



**Директор Дивизиона Специальных Подшипников ОАО «ЕПК»
Генеральный директор ОАО «ЗАП» Макаrchук В.В.**

**V.V. Makarchuk, EBC Special Bearings Division Director,
OJSC «Aviation Bearing Plant» Director General**



КАТАЛОГ – 2006

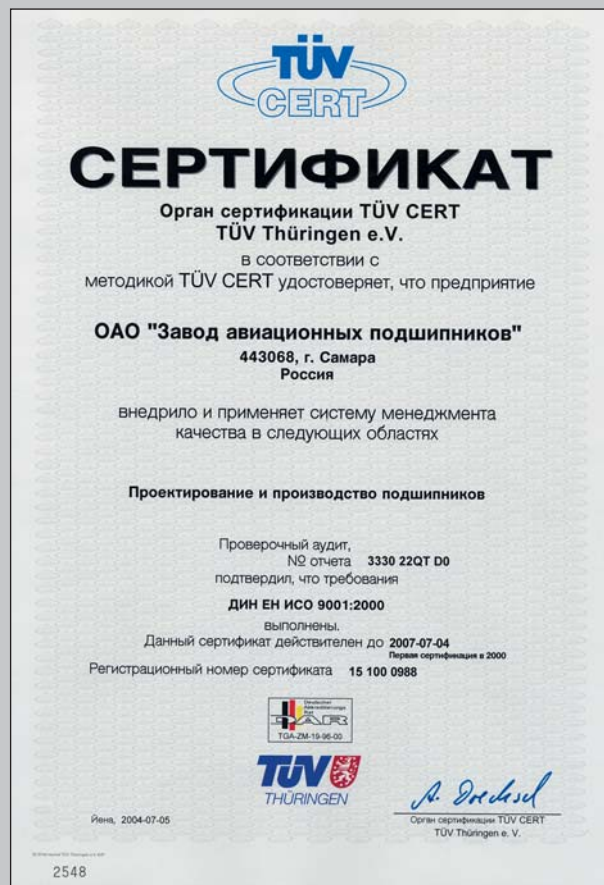

На всех стадиях производственного процесса действует строгий контроль качества, основывающийся на развитой сети экспериментальных и исследовательских лабораторий. На заводе дислоцируется военное представительство МО РФ № 111. На нашем предприятии внедрена система менеджмента качества, соответствующая требованиям международного стандарта ИСО 9001. Полувековой опыт производства, оборонные технологии, международные сертификации гарантируют высокое качество и длительный срок службы подшипников.

Strict quality control is maintained at all stages of manufacturing process based on a well-developed network of experimental and research laboratories. All our bearings of aerospace and military application undergo extra complex testing to be approved by the Quality Control Agency of the Ministry of Defense of the Russian Federation.

The plant's quality management system meets all the up-to-date demands and is certified according to ISO-9001 standard.

Fifty-year-long experience in bearings manufacturing, Soviet military technologies and international certifications guarantee high quality and durability of our products.

**Россия, 443068, г. Самара, ул. Мичурина 98 А
ДИРЕКЦИЯ Тел.: +7(846) 338-72-30, 335-58-25;
факс: +7(846) 222-8-999; e-mail: office@samzap.ru
ОТДЕЛ СБЫТА Тел.: +7(846) 338-71-91, 338-75-25;
факс: +7(846) 338-76-21; e-mail: sbit15@samzap.ru**

**98 A, Michurina str., Samara, Russia, 443068
ADMINISTRATION Тел.: +7(846) 338-72-30, 335-58-25;
Fax: +7(846) 222-8-999; e-mail: office@samzap.ru
SALES DEPARTMENT Тел.: +7(846) 338-71-91, 338-75-25;
Fax: +7(846) 338-76-21; e-mail: sbit15@samzap.ru**

ЕПК



**ОАО «ЗАВОД
АВИАЦИОННЫХ ПОДШИПНИКОВ»**

OJSC «AVIATION BEARING PLANT»

ПОДШИПНИКИ ШАРИКОВЫЕ РАДИАЛЬНЫЕ ОДНОРЯДНЫЕ

SINGLE-ROW RADIAL BALL BEARINGS

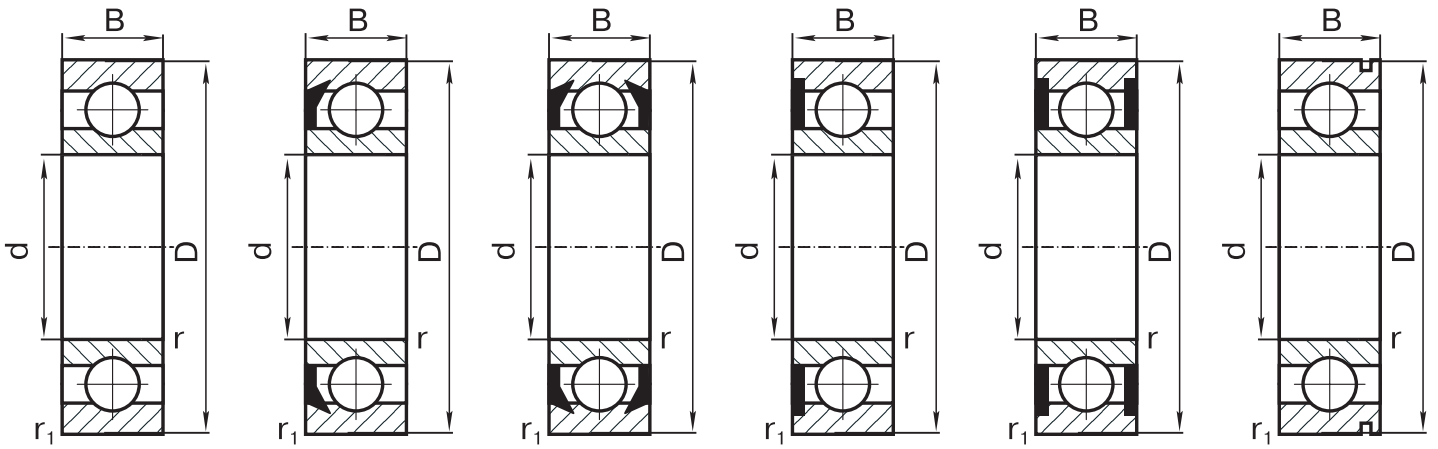

Эскиз 1 Drawing 1 Эскиз 2 Drawing 2 Эскиз 3 Drawing 3 Эскиз 4 Drawing 4 Эскиз 5 Drawing 5 Эскиз 6 Drawing 6

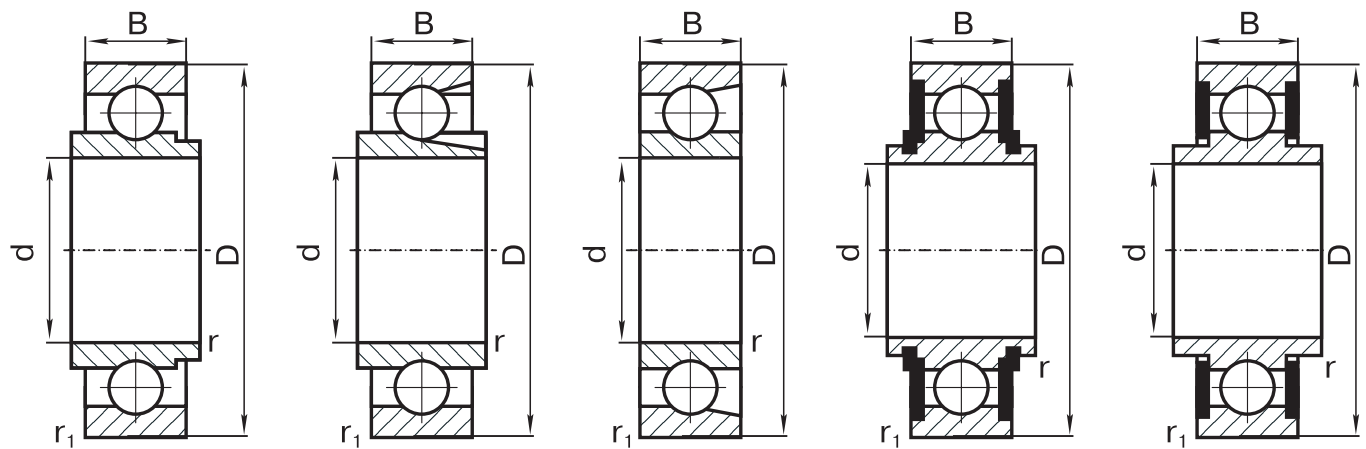

Эскиз 7 Drawing 7 Эскиз 8 Drawing 8 Эскиз 9 Drawing 9 Эскиз 10 Drawing 10 Эскиз 11 Drawing 11

Размеры/Dimensions					Обозначение/ Designation		Эскиз №/Drawing #	Грузоподъемность/ Load rating		Макс. Скорость/ Limiting Speed		Вес/ Weight
d	D	B	r min	r1 min				C	C _o	Пластичная смазка/ Grease	Жидкая смазка/ Oil	
мм/mm					Россия/ Russia	ИСО/ ISO		Н/Н		мин ⁻¹ /min ⁻¹		кг/kg
10	28	8	0,3	0,3	700	16100	1	5010	2150	20000	26000	0,023
	30	9	0,6	0,6	200	6200	1	5900	2650	240000	30000	0,03
	30	9	0,6	0,6	60200	6200-Z	2	5900	2650	24000	-	0,03
	30	9	0,6	0,6	80200	6200-2Z	3	5500	2650	24000	-	0,03
	30	9	0,6	0,6	150200	6200-ZN	6	5970	2470	20000	-	0,0299
	30	14	0,6	0,3	180500	62200-2RS	5	5500	2650	17000	-	0,048
12	24	6	0,3	0,3	1000901	61901	1	3390	1350	28000	34000	0,01
	28	7	0,3	0,3	7000101	16001	1	5070	2240	26000	32000	0,018
	28	8	0,3	0,3	101	600	1	5070	2240	26000	32000	0,02
	28	8	0,3	0,3	60101	6001-Z	2	5070	2240	26000	-	0,02
	28	8	0,3	0,3	80101	6001-2Z	3	5070	2240	26000	-	0,021
	28	8	0,3	0,3	180101	6001-2RS	5	5100	2400	20000	-	0,04694
	32	10	0,6	0,6	201	6201	1	6890	3100	22000	28000	0,037
	32	10	0,6	0,6	80201	6201-2Z	3	6890	3100	22000	-	0,037
	32	10	0,6	0,6	180201	6201-2RS	5	6890	3100	15000	-	0,038
	32	14	0,6	0,3	160501	60201-RS	4	6700	2920	15000	-	0,05
	32	14	0,6	0,3	180501	62201-2RS	5	6800	3100	15000	-	0,05
	37	12	1,0	1,0	301	6301	1	9750	4650	19000	24000	0,059
	37	12	1,0	1,0	80301	6301-2Z	3	9750	4650	19000	-	0,057
	37	12	1,0	1,0	60301	6301-Z	2	9750	4650	19000	-	0,0588
12,7	28,575	6,35	0,3	0,3	901	-	1	5120	2220	19000	24000	0,018
14	45	26	0,6	1,0	580902	-	3	13500	6100	13600	-	0,1334
15	32	8	0,3	0,3	7000102	16002	1	5590	2500	22000	28000	0,027
	32	9	0,3	0,3	102	6002	1	5590	5590	22000	28000	0,027
	32	9	0,3	0,3	60102	6002-Z	2	5600	2900	17000	-	0,02946
	32	9	0,3	0,3	80102	6002-2Z	3	5590	2500	22000	-	0,03
	35	11	0,6	0,6	202	6202	1	7800	3550	19000	24000	0,046
	35	11	0,6	0,6	60202	6202-Z	2	7800	3550	19000	-	0,046
	35	11	0,6	0,6	80202	6202-2Z	3	7800	3550	19000	-	0,046
	35	11	0,6	0,6	160202	6202-RS	4	7600	3480	16000	-	0,04435
	35	14	0,6	0,3	180502	6202-2RS	5	7800	3550	13000	-	0,071
	35	15,9	0,6	0,3	3160202	6202-RSX	4	7800	3550	13000	-	0,062
	35	15,9	0,6	0,3	3180202	6202-2RSX	5	7800	3550	13000	-	0,061
	42	13	1,0	1,0	302	6302	1	11400	5400	17000	20000	0,107
	42	13	1,0	1,0	80302	6302-2Z	3	11400	5400	12000	-	0,0824
	42	13	1,0	1,0	180302	6302-2RS	5	11400	5400	12000	-	0,084
42	17	1,0	1,0	180602	62302-2RS	5	10200	4640	12000	-	0,109	
15,875	34,925	7,144	0,6	0,6	902	-	1	7650	3480	17000	20000	0,028
16	35	11	0,6	0,6	60902	-	2	7650	3480	16000	-	0,043
	35	11	0,6	0,6	180902	-	5	7650	3480	16000	-	0,054
	30	7	0,3	0,3	1000903	61903	1	3640	1650	20000	26000	0,023
17	35	8	0,3	0,3	7000103	16003	1	6050	2800	19000	24000	0,036
	35	10	0,3	0,3	103	6003	1	6050	2800	19000	24000	0,038
	35	10	0,3	0,3	60103	6003-Z	2	6050	2800	19000	-	0,042
	35	10	0,3	0,3	80103	6003-2Z	3	6050	2800	19000	-	0,042
	40	12	0,6	0,6	203	6203	1	9560	4500	17000	20000	0,055
	40	12	0,6	0,6	60203	6203-Z	2	9560	4500	17000	-	0,065
	40	12	0,6	0,6	80203	6203-2Z	3	9560	4500	17000	-	0,064
	40	12	0,6	0,6	180203	6203-2RS	5	9560	4500	12000	-	0,067
	40	16	0,6	0,6	80503	62203-2Z	3	9560	4500	12000	-	0,079
	47	16	0,6	0,6	180503	62203-2RS	5	12428	4500	12000	-	0,083
	47	14	1,0	1,0	80303	6303-2Z	3	13500	6650	16000	-	0,1128
	47	14	1,0	1,0	303	6303	1	13500	6650	16000	19000	0,109
	47	19	1,0	1,0	180603	62303-2RS	5	13500	6650	16000	-	0,149
	40	14	0,3	0,3	80803	-	3	9600	4600	14000	-	0,077
	26	6	0,3	0,3	900803	-	8	3200	2600	18600	25600	0,0118
	42	13	1,0	1,0	180903	-	5	11400	5400	13600	-	0,0824

Размеры/Dimensions					Обозначение/ Designation		Эскиз №/Drawing #	Грузоподъемность/ Load rating		Макс. Скорость/ Limiting Speed		Вес/ Weight
d	D	B	r min	r1 min				C	C _o	Пластичная смазка/ Grease	Жидкая смазка/ Oil	
мм/mm					Россия/ Russia	ИСО/ ISO		Н/Н		мин ⁻¹ /min ⁻¹		кг/kg
17	62	17	1,1	1,1	970403	-	8	65200	48400	10100	13900	1,32
	62	17	1,3	1,3	403	6403	1	22900	11800	1200	15000	0,279
17,7	35	8	0,3	0,3	903	-	1	6000	3300	17000	20000	0,0295
20	32	4	0,3	0,3	7000804	60804	1	1740	1180	20000	26000	0,014
	32	7	0,3	0,3	1000804	61804	1	2700	1500	16000	20000	0,0166
	37	9	0,3	0,3	1000904	61904	1	6550	3040	18000	22000	0,035
	42	9	0,7	0,7	100704	-	1	8700	4500	14500	-	0,0647
	42	8	0,3	0,3	7000104	16004	1	7900	4400	17000	20000	0,05
	42	12	0,6	0,6	970104	-	8	13200	8500	12900	17800	0,0704
	42	12	0,6	0,6	50104	6004N	6	9360	4500	17000	20000	0,067
	42	12	0,6	0,6	104	6004	1	9360	4500	17000	20000	0,069
	42	12	0,6	0,6	80104	6004-ZZ	3	9360	4500	17000	-	0,068
	47	14	1,0	1,0	50204	6204N	6	12700	6200	15000	18000	0,127
	47	14	1,0	1,0	204	6204	1	12700	6200	15000	18000	0,107
	47	14	1,0	1,0	60204	6204-Z	2	12700	6200	15000	-	0,106
	47	14	1,0	1,0	80204	6204-ZZ	3	12700	6200	15000	-	0,104
	47	18	1,0	1,0	180504	62204-2RS	5	12700	6200	10000	-	0,14
	47	20,6	1,0	1,0	3180204	-	5	12700	6200	10000	-	0,165
	47	21	1,1	1,1	180604	62304-2RS	5	16000	7800	10000	-	0,208
	52	15	1,1	1,1	304	6304	1	15900	7800	13000	16000	0,177
25	37	4	0,3	0,3	7000805	-	1	1740	1180	16000	20000	0,016
	37	7	0,3	0,3	1000805	61805	1	3120	1980	17000	20000	0,021
	42	9	0,3	0,3	1000905	61905	1	7320	3680	15000	18000	0,042
	47	12	0,6	0,6	905P1	-	1	10070	5800	12500	15000	0,095
	47	8	0,6	0,6	7000105	16005	1	7610	4000	14000	17000	0,056
	47	12	0,6	0,6	105	6005	1	11200	5600	15000	18000	0,0648
	47	12	0,6	0,6	60105	6005-Z	2	11200	5600	15000	-	0,064
	47	12	0,6	0,6	80105	6005-ZZ	3	11200	5600	15000	-	0,068
	52	10	1,0	1,0	705	-	1	14000	6950	13000	16000	0,091
	52	15	1,0	1,0	60205	6205-Z	2	14000	6950	13000	-	0,120
	52	15	1,0	1,0	205	6205	1	14000	6950	12000	15000	0,125
	52	15	1,0	1,0	80205	6205-ZZ	3	14000	6950	12000	-	0,126
	52	15	1,0	1,0	160205	6205-RS	4	14000	6950	8500	-	0,117
	52	15	1,0	1,0	180205	6205-2RS	5	14000	6950	8500	-	0,136
	52	18	1,0	1,0	180505	62205-2RS	5	14000	6950	8500	-	0,143
	52	17	1,1	1,1	305	6305	1	22500	11400	11000	14000	0,277
	62	17	0,2	0,7	50305	6305N	6	22500	11400	11000	14000	0,129
	62	17	1,1	1,1	180305	6305-2RS	5	22500	11600	9200	-	0,239
	62	24	1,1	1,1	180605	62305-2RS	5	22500	11400	11000	-	0,354
80	21	1,8	1,8	970405	-	8	40500	25000	8500	10500	0,595	
30	42	4	0,3	0,3	7000806	-	1	1820	1180	13000	16000	0,019
	42	7	0,3	0,3	1000806	61806	1	3420	2350	15000	18000	0,026
	47	9	0,3	0,3	1000906	61906	1	7590	4000	13000	16000	0,049
	55	9	0,3	0,3	7000106	16006	1	11200	5850	12000	15000	0,100
	55	13	1,0	1,0	106	6006	1	13300	6800	12000	15000	0,12
	55	13	1	1	80106C9	6006-ZZ	3	12700	8030	9400	-	0,120
	62	16	1,0	1,0	206	6206	1	19500	10000	10000	13000	0,20
	62	16	1,0	1,0	60206	6206-Z	2	19400	11200	8700	-	0,205
	62	16	1,0	1,0	80206	6206-ZZ	3	19400	11200	8695	-	0,211
	62	16	1,0	1,0	180206	6206-2RS	5	19400	11200	8700	-	0,2178
	72	19	1,1	1,1	306	6306	1	28100	14600	9000	11000	0,34
	72	19	1,1	1,3	50306	6306N	6	28100	14600	9000	11000	0,34
	72	19	1,1	1,1	180306	6306-2RS	5	28100	14600	9000	-	0,352
	42	7/6	0,3	0,3	706	-	7	3440	1850	13000	16000	0,026
42	7/6	0,3	0,3	900706	-	8	5120	4330	5000	6300	0,027	
62	16	1,1	1,1	970206	-	8	27300	18600	8700	12000	0,225	
35	75	19	1,1	1,1	50706	615722	6	32900	17600	8500	10500	0,384

Размеры/Dimensions					Обозначение/ Designation		Эскиз №/Drawing #	Грузоподъемность/ Load rating		Макс. Скорость/ Limiting Speed		Вес/ Weight
d	D	B	r min	r1 min	Россия/ Russia	ИСО/ ISO		C	C _o	Пластичная смазка/ Grease	Жидкая смазка/ Oil	
мм/mm										Н/Н		мин ⁻¹ /min ⁻¹
35	62	20	1,0	1,0	180506	62206-2RS	5	15000	9300	8700	-	0,255
	47	8/7	0,3	0,3	7690906	-	7	5480	3090	10000	13000	0,042
	47	4	0,3	0,3	7000807	60807	1	1820	1180	13000	16000	0,021
	47	7	0,3	0,3	10000807	61807	1	4030	3000	13000	16000	0,029
	62	14	1,0	1,0	107	6007	1	15900	850	10000	13000	0,165
	62	9	1,0	1,0	7000107	16007	1	9800	7400	8250	11300	0,13
	72	17	1,0	1,0	207	6207	1	25500	13700	9000	11300	0,13
	72	17	1,1	1,1	50207	6207N	6	25500	13700	9000	11000	0,28
	72	17	1,1	1,1	80207	6207-2Z	3	25500	13700	9000	-	0,288
	72	21	1,1	1,1	160707	-	4	25700	15200	8411	10280	0,312
	80	21	1,5	1,5	307	6307	1	33300	19200	7800	9500	0,456
80	21	1,5	1,5	50307	6307N	6	33400	19300	7800	9600	0,436	
40	80	18	1,1	1,1	150208	6208ZN	6	32600	19900	7500	9200	0,367
	52	4	0,3	0,3	7000808	6108	1	1820	1180	10000	13000	0,024
	52	7	0,3	0,3	1000808	61808	1	4420	2970	11000	14000	0,036
	52	7	0,3	0,3	900808	-	8	6900	8000	7800	10800	0,035
	62	12	0,6	0,6	1000908	61908	1	1220	6900	10000	13000	0,102
	68	15	1,0	1,0	108	6008	1	16800	9300	9500	12000	0,194
	68	15	1,0	1,0	80108	6008-2Z	3	16800	9300	9500	-	0,19
	68	9	1,0	1,0	7000108	16008	1	13200	10300	7400	10200	0,1507
	80	18	1,1	1,1	208	6208	1	32000	17800	8500	10000	0,36
	80	23	1,1	1,1	160508	62208-RS	4	27600	17500	6600	9150	0,477
	80	23	2,2	1,3	180508	62208-2RS	5	32600	19900	6700	-	0,433
80	23/41			480508	-		32600	12900	6700	9200	0,586	
90	23	1,5	1,5	308	6308	1	41000	22400	7500	9200	0,367	
45	57	7/6	0,3	0,3	900809	-	8	6990	6180	8800	10000	0,035
	58	7	0,3	0,3	1000809	61809	1	6050	3800	1100	1400	0,043
	58	8	0,3	0,3	2000809	-	1	4300	2960	9500	12000	0,049
	68	12	0,6	0,6	109	6009	1	21200	12200	9000	11000	0,121
	75	11	0,6	0,6	709	16009	1	4300	2960	9500	12000	0,049
	85	19	1,3	1,3	209	6209	1	32700	20300	6900	8500	0,492
	85	21/29	1,3	1,3	530209	-	5	32700	20300	6900	-	0,47
	85	19	1,1	1,1	50209	6209N	6	36400	22400	6900	8500	0,4
	85	30,2	1,1	1,1	3180209	-	5	33200	18600	5000	-	0,652
	100	25	1,5	0,5	50309	6309N	6	52700	30000	6700	8000	0,79
	100	25	1,5	1,5	80309	6309-2Z	3	52700	30000	6700	-	0,801
	100	25	1,5	1,5	309	6309	1	48200	26000	6700	-	0,805
	100	25	1,5	0,5	60309	6309-Z	2	48200	26000	6700	-	0,8
	100	25	1,5	1,5	150309	6309-ZN	6	48300	27751	6206	7586	0,79
	120	29	2,0	2,0	50409	6409N	1	76100	45500	10000	7000	1,5
120	29	2,0	2,0	700409	-	9	76100	45500	10000	13000	1,64	
120	29	2,0	2,0	409	6409	1	98930	45500	6000	7000	1,52	
50	72	8	0,3	0,3	7000910	60910	1	9500	6450	8000	10000	0,098
	80	16	1,0	1,0	110	6010	1	21600	13200	8500	1000	0,47
	80	24	1,1	1,1	520110	-	7	20700	15500	6200	8500	0,3
	90	20	1,1	1,1	210	6210	1	35100	19800	7000	8500	0,47
	80	10	0,7	0,7	7000110	16010	1	13800	11900	6150	8500	0,2126
	110	27	2,3	2,3	310	6310	1	61700	37700	5600	6900	1,36
	80	11	0,7	0,7	710	16010	1	13800	11900	6900	8500	0,213
55	72	7	0,3	0,3	7000811	-	1	4690	3700	8000	10000	0,078
	80	13	1,0	1,0	1000911	61911	1	16000	10000	7500	9500	0,193
	90	18	1,1	1,1	111	6011	1	28100	17000	7500	9000	0,513
	90	11	0,7	0,7	7000111	16011	1	16400	14200	5500	7600	0,307
	100	21	1,5	1,5	211	6211	1	43600	25000	6300	7500	0,600
	120	29	2,0	2,0	170311	311N	1	71300	44300	5142	6285	1,416
	120	29	2,0	2,0	50311	6311N	6	71500	41500	5600	6700	1,330
120	29	2,0	2,0	80311	6311-2Z	3	71500	41500	5600	-	1,37	

Размеры/Dimensions					Обозначение/ Designation		Эскиз №/Drawing #	Грузоподъемность/ Load rating		Макс. Скорость/ Limiting Speed		Вес/ Weight
d	D	B	r min	r1 min				C	C _o	Пластичная смазка/ Grease	Жидкая смазка/ Oil	
мм/mm					Россия/ Russia	ИСО/ ISO		Н/Н		мин ⁻¹ /min ⁻¹		кг/kg
55	120	29	2,0	2,0	311	6311	1	71500	41500	5600	6700	1,35
	120	29	2,0	2,0	60311	6311-Z	2	71500	41500	5600	-	1,373
	140	33	2,1	2,1	50411	6411N	6	100000	63000	5000	6000	2,28
	140	33	2,1	2,1	411	6411	1	100000	63000	5000	6000	2,3
60	78	10	0,3	0,3	1000812	61812	1	8710	7350	7500	9000	0,102
	85	13	1	1	1000912	61912	1	16400	10600	6300	8000	0,248
	95	18	1,1	1,1	112	6012	1	29600	18300	6700	8000	0,404
	95	18	1,1	1,1	80112	6012-ZZ	3	29600	18300	6700	-	0,426
	110	22	1,5	1,5	212	6212	1	52000	31000	6000	7000	0,797
	110	22	1,5	1,5	60212	6212-Z	2	52000	31000	6000	-	0,793
	110	22	1,5	1,5	80212	6212-ZZ	3	52000	31000	6000	-	0,805
	110	28	1,5	1,5	160512	62212-RS	4	52430	30900	4000	-	1,032
	150	35	2,1	2,1	412	6412	1	108000	70000	4800	5600	2,8
	150	35	2,1	2,1	50412	6412N	6	108000	70000	4800	5600	2,800
	95	18	1,1	1,1	60112	6012-Z	2	30600	22800	5200	-	0,4069
	110	22	1,5	1,5	150212	6212-ZN	6	52500	35800	5300	6500	0,78
65	85	10	0,7	0,7	1000813	61813	1	10700	9900	6000	7300	0,149
	100	11	0,6	0,6	7000113	16013	1	19000	13000	6300	7500	0,312
	100	18	1,1	1,1	113	6013	1	30700	19600	6300	7500	0,452
	100	18	1,1	1,1	80113	6013-ZZ	3	30740	19600	6300	-	0,453
	100	30	-	1,1	520113	-	10	30700	24900	4800	6700	0,56
	120	23	1,8	1,8	213	6213	1	57000	40000	4800	6000	1,05
	160	37	2,1	2,1	413	6413	1	119000	78100	4500	5300	3,44
	160	37	2,1	2,1	50413	6413N	6	119000	78100	4500	5300	3,40
70	90	10	0,6	0,6	1000814	61814	1	12100	9150	6700	8000	0,16
	110	13	0,6	0,6	7000114	16014	1	22200	15300	6000	7000	0,51
	110	20	1,3	1,3	114	6014	1	38700	30300	5000	6100	0,725
	125	24	1,5	1,5	214	6214	1	61800	37500	5000	6000	1,08
	150	35	2,1	2,1	50314	6314N	6	104000	63000	4500	5300	2,50
	180	42	3	3	50414	6414N	6	143000	105000	3800	4500	5,25
75	105	16	1,0	1,0	10009015	61915	1	24300	16800	5600	7000	0,37
	115	20	1,1	1,1	115	6015	1	39700	26000	5600	6700	0,66
	130	25	1,5	1,5	215	6215	1	66300	41000	4800	5600	1,18
80	100	10	0,6	0,6	1000816	61816	1	12400	9800	6000	7000	0,19
	110	16	1,0	1,0	1000916	61916	1	27500	18900	5300	6700	0,34
	125	22	1,1	1,1	116	6016	1	47700	31500	5300	6300	1,02
	140	26	2,0	2,0	216	6216	1	70200	45000	5300	6300	1,400
	170	39	2,1	2,1	316	6316	1	124000	80000	3800	4500	3,58
	170	39	3,4	3,4	50316	6316N	6	122800	86200	3600	4400	3,54
	200	48	3,0	3,0	416	6416	1	163000	125000	3400	4000	7,00
85	120	18	1,1	1,1	1000917	61917	1	31900	22200	4000	5000	0,70
	130	22	1,1	1,1	117	6017	1	49400	33500	5000	6000	1,08
	130	28	2,0	2,0	217	6217	1	83200	53000	4300	5000	1,80
	150	41	3,0	3,0	317	6317	1	133000	90000	3600	4300	4,24
	180	41	3,0	3,0	50317	6317N	6	133000	90000	3600	4300	4,20
	180	41	3,0	3,0	170317	-	1	132500	96070	3396	4150	4,31
	210	52	4,0	4,0	417	6417	1	174000	135000	3200	3800	7,93
90	115	13	1,0	1,0	1000818	61818	1	19500	15600	5300	6300	0,332
	125	18	1,1	1,1	1000918	61918	1	32900	23500	4500	5600	0,72
	140	24	1,5	1,5	950118	-	9	68600	52600	3800	4500	1,463
	140	24	1,5	1,5	118	6018	1	57200	39000	4800	5600	1,2
	140	40/30	1,5	1,5	2310118	-	10	52300	35000	3500	-	1,63
	160	30	1,3	1,3	218	6218	1	9600	71000	3600	4400	2,76
	125,2	18	1,3	1,3	718	-	1	33000	31400	4200	5200	0,6114
95	130	18	1,1	1,1	1000919	61919	1	32900	23500	4000	5000	0,74
	145	24	1,8	1,8	119	6019	1	60500	41500	4500	5300	1,6
100	140	20	1,1	1,1	1000920	61920	1	44900	32000	4000	5000	1,02

Размеры/Dimensions					Обозначение/ Designation		Эскиз №/Drawing #	Грузоподъемность/ Load rating		Макс. Скорость/ Limiting Speed		Вес/ Weight
d	D	B	r min	r1 min				C	C _o	Пластичная смазка/ Grease	Жидкая смазка/ Oil	
мм/mm					Россия/ Russia	ИСО/ ISO		Н/Н		мин ⁻¹ /min ⁻¹		кг/kg
100	150	24	1,5	1,5	50120	6020N	6	60500	41500	4300	5000	1,6
	150	24	1,5	1,5	80120	6020-ZZ	3	60500	41500	4300	-	1,28
	150	24	1,5	1,5	60120	6020-Z	2	60500	41500	4300	-	1,29
	150	24	1,5	1,5	120	6020	1	60500	41500	4300	5000	1,29
	215	47	3,0	3,0	320	6320	1	174000	132000	3000	3600	7
	215	47	3,0	3,0	170320	-	1	173100	140800	2857	3492	7,296
105	130	113	1,0	1,0	1000821	61821	1	20800	18000	4300	5000	0,4
	145	20	1,1	1,1	1000921	61921	1	46500	33500	3200	4000	0,82
	160	26	2,0	2,0	121	6021	1	72800	51000	4000	4800	1,55
	160	26	2,0	2,0	60121	6021-Z	2	72800	51000	4000	4800	1,56
110	140	16	1,0	1,0	1000822	61822	1	28100	23600	4300	5000	0,61
	150	20	1,1	1,1	1000922	61922	1	44400	45000	3100	4200	1,1
	170	28	2	2	50122	6022N	6	81900	57000	3800	4500	2,3
	170	28	2	2	122	6022	1	81900	57000	3800	4500	2,3
	200	38	2,1	2,1	50222	6222N	6	146000	100000	3000	3600	5,49
	200	38	2,1	-	60222	6222-Z	2	146000	100000	3000	3600	4,5
	200	38	2,1	2,1	222	6222	1	146000	100000	3000	3600	4,42
	200	38	2,1	2,1	80222	6222-ZZ	3	146000	100000	3000	-	4,6
	240	50	3	3	322	6322	1	204500	177000	2500	3100	12,12
	215	40	2,1	2,1	80722	-	3	155600	129000	2700	-	6,02
120	150	10	0,6	0,6	7000824	-	1	7720	4950	3800	4500	0,425
	150	16	1	1	1000824	61824	1	29100	25500	3800	4500	0,7
	165	22	1,1	1,1	1000924	61924	1	53300	40000	3200	4000	1,54
	180	19	1	1	7000124	16024	1	40355	33310	3000	3666	1,91
	180	28	2	2	124	6024	1	85000	61000	3400	4000	2,19
	180	28	2	2	80124	6024-ZZ	3	85000	61000	3400	-	2,12
	215	40	2,1	2,1	224	6224	1	156000	112000	2800	3400	5,24
	215	40	2,1	2,1	80224	6224-ZZ	3	156000	112000	2800	-	5,47
130	165	18	1,1	1,1	1000826	61826	1	49200	56050	2400	3200	1,45
	180	24	1,5	1,5	1000926	61926	1	65300	50000	2600	3200	1,84
	200	33	2	2	126	6026	1	106000	78000	3200	3800	3,33
135	185	24	1,5	1,5	1000727	-	1	64700	50200	2600	3200	2,06
140	175	18	1,1	1,1	1000828	61828	1	38000	35500	3400	4000	1,08
	175	26	1,1	1,1	3180828	-	5	34000	31150	2800	-	1,24
	190	24	1,5	1,5	1000928	61928	1	66600	53000	2600	3200	2,16
145	206	26	1,5	-	470729	-		53600	62300	2300	3100	3,026
150	225	35	2,5	2,5	130	6030	1	126000	125600	2400	2900	5,12
	270	45	3	3	230	6230	1	189000	150000	2000	2600	12,3
160	200	20	1,1	1,1	1000832	61832	1	49400	45500	2800	3400	1,462
170	215	22	2,0	2,0	1000834	61834	1	59800	70400	2070	2860	2,05
	230	28	2,0	2,0	1000934	61934	1	88900	75000	2000	2600	3,03
180	225	22	1,1	1,1	1000836	61836	1	62400	57000	2400	3000	2,03
190	240	24	1,5	1,5	1000838	61838	1	74100	69500	2000	2600	2,71
200	250	24	1,8	1,8	1000840	61840	1	68900	87600	2000	2400	2,86
	280	38	2,1	2,1	1000940	61940	1	148000	125000	2000	2600	7,64
220	270	24	1,5	1,5	1000844	61844	1	78000	78000	1900	2400	3,3
	340	37	2,1	2,1	7000144	16044	1	174000	153000	1800	2200	13,5
240	320	38	2,5	2,5	1000948	61948	1	143200	177000	1600	2000	9,6
280	350	33	2,0	2,0	1000856	61856	1	138000	140000	1600	1900	9,5
	380	46	2,1	2,1	1000956	61956	1	216000	212000	1500	1800	15
320	400	38	2,1	2,1	1000864	61864	1	174000	182000	1300	1600	11,8
340	420	38	2,1	2,1	1000868	61868	1	178000	196000	1200	1500	12,3

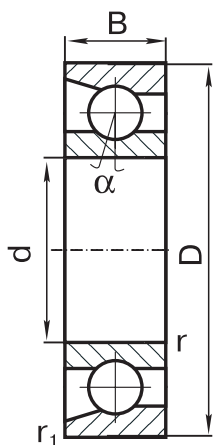

Эскиз 1
Drawing 1

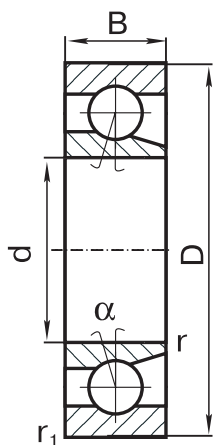

Эскиз 2
Drawing 2

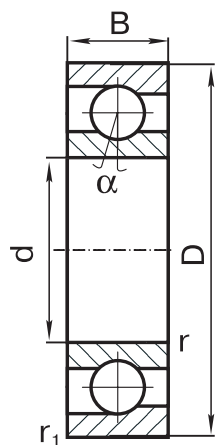

Эскиз 3
Drawing 3

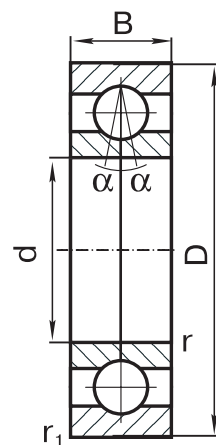

Эскиз 4
Drawing 4

Размеры/Dimensions					Обозначение/ Designation		Эскиз №/Drawing #	Грузоподъемность/ Load rating		Макс. Скорость/ Limiting Speed		Вес/ Weight
d	D	B	r min	r1 min				C	C _o	Пластичная смазка/ Grease	Жидкая смазка/ Oil	
мм/mm					Россия/ Russia	ИСО/ ISO		Н/Н		мин ⁻¹ /min ⁻¹		кг/kg
10	30	9	0,6	0,3	36200	B7200C	3	5040	2343	20000	27500	0,03
12	28	8	0,3	0,15	36101	B7001C	1	4270	2500	31500	40000	0,022
	32	7	0,6	0,3	6012	E12	1	6280	2990	24000	30000	0,0288
	32	10	0,6	0,3	66201	7201B	2	6632	2812	13000	18000	0,031
	32	10	0,6	0,3	36201	B7201C	1	7150	3340	24000	32000	0,036
15	35	8	0,6	0,3	6015	E15	1	10165	6114	16000	22000	0,035
	32	9	0,5	0,3	36102	B7002C	1	6290	2990	30000	40000	0,033
	35	11	0,6	0,15	66202	7202B	2	7209	3154	12000	16500	0,0455
	35	11	0,6	0,3	36202	B7202C	2	8150	3830	24000	32000	0,045
	35	11	0,6	0,3	46202	B7202E	1	8250	3650	18000	22000	0,045
17	35	11	0,6	0,6	276202	-	4	7150	3490	16000	22000	0,474
	40	12	0,6	0,3	66203	7203B	2	8680	4700	14000	19300	0,056
	30	7	0,3	0,1	1036903	B71903C	2	3800	2450	17000	23000	0,0186
	30	7	0,5	0,3	1076903	-	2	3000	1800	17000	23400	0,018
	35	10	0,3	0,15	46103	B7003E	2	5909	2750	15000	21000	0,0418
	35	10	0,3	0,15	36103	B7003C	2	5700	3600	28000	36000	0,042
	35	10	0,3	0,15	76103	-	1	5200	3240	15400	21100	0,040
	40	12	0,6	0,3	46203	B7203E	1	11340	5740	14000	19000	0,0811
	40	12	0,6	0,3	36203	B7203C	1	12000	5120	18000	24000	0,063
	40	12	0,6	0,6	276203	-	4	10700	5100	16000	20000	0,08
	47	14	1,0	0,6	36303	B7303C	1	17200	8700	13000	17000	0,134
47	14	1,0	0,6	46303	B7303E	1	16100	8000	13000	17000	0,109	
47	14	1,1	1,1	276303	-	4	16000	8020	12500	17200	0,136	
20	47	12	1,0	0,6	6020	E20	1	15600	8940	12000	16500	0,101
	42	12	0,6	0,3	6104	-	1	9070	4230	13000	18000	0,065
	42	12	0,6	0,3	36104	B7004C	2	10600	5320	22000	30000	0,075
	47	14	1,0	0,6	36204	B7204C	1	15700	8310	16000	20000	0,101
	47	14	1,0	0,6	46204	B7204E	1	14800	7640	15000	20000	0,101
	52	15	1,3	1,3	46304	B7304E	3	17800	9500	11000	15300	0,183
	52	15	1,1	1,1	276304	-	4	17800	9000	14000	18000	0,195
25	52	25	1,1	1,1	46205	B7205E	1	15800	9700	10400	14300	0,142
	62	17	1,1	0,6	46305	B7305E	1	25800	15470	9200	12600	0,283
	42	9	0,5	0,3	1036905	B71905C	2	8230	4441	12000	16000	0,0424
	47	12	0,6	0,3	36105	B7005C	2	10800	5290	19000	24000	0,082
	52	9	1,0	0,6	66205	7205B	1	14625	7501	8000	10000	0,122
	52	15	1,0	0,6	36205	B7205C	1	16700	9100	13000	17000	0,123
30	62	16	1,0	1,0	36206	B7206C	1	23200	14900	8700	12000	0,2
	62	16	1,0	0,6	46206	B7206E	1	21900	13900	8700	11900	0,214
	90	23	1,5	1,0	66406	7406B	1	45700	27300	6700	9200	0,855
	55	13	1,0	0,6	36106	B7006C	2	15300	8570	17000	22000	0,128
35	80	21	1,5	1,0	46307	B7307E	3	40030	24770	6950	9560	0,586
	42	4	0,5	0,5	7036806	-	1	800	560	11120	15200	0,017
	47	9	0,5	0,3	1036906	B71906C	2	8300	4840	11000	14000	0,0525
	47	4	0,5	0,5	7076807	-	2	1360	1220	10000	13400	0,018
	55	7	0,3	0,3	7046907	-	1	7480	4690	9000	12000	0,067
	62	14	1,0	0,6	46107	B7007E	2	18103	10417	8000	11000	0,155
	62	14	1,0	0,6	36107	B7007C	1	19100	11300	16000	20000	0,157
	72	17	1,1	0,6	66207	7207B	1	27000	14700	8000	9000	0,29
	72	17	1,1	0,6	36207	B7207C	1	30800	17800	10000	12000	0,289
72	17	1,1	1,1	276207	-	4	29000	16300	12000	15000	0,368	
40	68	15	1,0	0,6	36108	B7008C	2	15606	11681	7404	10185	0,192
	62	12	0,6	0,15	1036908	B71908C	2	13125	11022	7800	10700	0,121
	80	18	1,0	0,6	46208	B7208E	3	34700	22600	6700	9100	0,458
	62	12	0,6	0,15	1046908	B71908E	2	12700	7800	8000	11000	0,121
	68	15	1,0	0,6	76108	-	1	11700	10300	7400	10000	0,200
	80	18	1,1	0,6	36208	B7208C	1	38900	23200	9500	13000	0,36
80	18	1,1	0,6	136208	-	2	36730	21300	9500	13000	0,459	

Размеры/Dimensions					Обозначение/ Designation		Эскиз №/Drawing #	Грузоподъемность/ Load rating		Макс. Скорость/ Limiting Speed		Вес/ Weight
d	D	B	r min	r1 min				C	C _o	Пластичная смазка/ Grease	Жидкая смазка/ Oil	
мм/mm					Россия/ Russia	ИСО/ ISO		Н/Н		мин ⁻¹ /min ⁻¹		кг/kg
40	90	23	1,8	1,8	46308	B7308E	3	50000	33600	6150	8500	0,75
	90	23	1,5	1,0	66308	7308B	1	50343	30765	4500	6300	0,744
	110	27	2,0	1,0	66408	7408B	1	72200	42300	4300	5600	1,435
45	85	19	1,1	0,6	46209	B7209E	3	38700	27100	6150	8500	0,493
	85	19	1,1	1,1	276209	-	4	38800	27100	6150	8500	0,552
	75	16	1,0	0,6	76109	-	1	14127	12911	6600	9100	0,255
	85	19	1,1	0,6	36209	B7209C	1	41200	25100	9000	12000	0,404
	100	25	1,5	1,0	66309	7309B	1	60800	36400	5600	7500	0,87
	90	20	1,1	0,6	46210	B7210E	3	40500	30200	5700	7800	0,448
50	72	8	0,3	0,3	7046910	-	1	8500	7600	6600	9000	0,102
	80	16	1,0	0,6	36110	B7010C	2	25055	16252	6000	8000	0,276
	80	16	1,0	0,6	46110	B7010E	2	23541	15123	6000	8000	0,276
	80	16	1,0	0,6	76110	-	1	14600	14100	6100	8400	0,277
	90	20	1,1	0,6	36210	B7210C	1	43200	27000	8000	11000	0,446
	110	27	2,3	2,3	26310	-	1	64300	44000	3750	5000	1,3
	120	29	2,0	1,0	66311	7311B	1	77300	53800	4600	6300	1,625
55	72	7	0,3	0,3	7076811	-		3500	3100	6300	8700	0,068
	90	18	1,1	0,6	46111	B7011E	1	32600	21100	5000	7500	0,444
	100	21	1,5	1,5	276111	-	4	50300	31500	8500	10000	1,044
	100	21	1,5	1,5	46211	B7211E	1	50300	37800	5100	7100	0,598
	120	29	3,0	1,5	46311	B7311E	1	82800	51600	4500	6300	1,42
	120	29	2,0	1,0	66311	7311B	1	77248	46480	3000	4500	1,625
	78	10	0,3	0,15	1006812	-	1	7740	7000	7500	9500	0,0972
60	95	18	1,1	0,6	46112	B7012E	1	37400	24500	5000	7000	0,475
	110	22	1,5	1,5	276212	-	4	58000	36100	7500	9500	1,014
	150	35	2,1	1,1	66412	7412B	2	115229	72904	2800	4000	3,98
	120	27	1,5	1,0	46213	B7213E	3	66100	52100	4300	6000	0,87
65	100	18	1,1	0,6	66113	7013B	1	5460	3650	4850	6700	0,533
	120	23	2,5	2,5	276913	-	4	59600	44600	4300	5900	1,1
	100	18	1,1	0,6	46113	B7013E	1	35000	24600	4800	7500	0,54
	100	18	1,1	0,6	36113	B7013C	2	37000	26500	7000	9500	0,44
	125	24	1,5	1,0	36214	B7214C	2	80300	64420	4100	5600	1,1
	110	20	1,1	0,6	46114	B7014E	1	45258	41000	4400	6100	0,606
70	110	20	1,1	1,1	276114	-	4	28100	21700	7500	9000	0,626
	125	24	1,5	1,5	276214	-	4	75300	50400	6300	8000	1,4
	180	42	3,0	1,1	66414	7414B	2	151729	108906	2400	3300	5,946
	130	25	1,5	1,0	46215	B7215E	3	71500	58300	3900	5360	1,082
75	160	37	2,1	1,1	66315	7315B	1	122197	79482	2500	3500	3,647
	146	30	2,5	2,5	276915	-	4	100690	65328	3600	5000	2,253
80	140	26,5	3,0	1,0	26216	-	1	65270	47630	3800	5000	1,309
	170	39	2,1	2,1	46316	B7316E	1	142160	110600	3200	4400	4,414
	200	48	3,0	1,1	66416	7416B	2	172376	129607	2000	3000	8,558
85	130	22	1,1	0,6	46117	B7017E	1	56241	55300	3700	5100	1,11
	150	28	2,0	2,0	276217	-	4	90000	60800	5000	6300	2,2
	180	41	3,0	1,1	36317	B7317C	1	162270	120031	3000	4000	4,34
	180	41	3,0	1,1	46317	B7317E	1	163000	120000	3000	4000	4,293
	180	41	3,0	1,1	66317	7317B	1	151306	108302	2200	3000	4,5
90	125	18	1,1	0,6	1036918	B71918C	2	34500	35500	3600	5000	0,617
	125	18	1,1	0,6	1046918	B71918E	2	34800	29000	3600	5000	0,617
	140	24	1,5	1,0	36118	B7018C	2	64500	48400	4800	6300	1,144
	160	31	2,0	2,0	276218	-	4	111040	76216	3200	4400	2,74
100	150	24	1,5	1,0	46120	B7020E	1	70890	72400	3200	4400	1,276
	140	20	1,1	0,6	1036920	B71920C	2	36500	39000	3300	4500	0,869
	180	34	2,1	1,1	66220	7220B	1	136452	96005	2000	3000	3,864
	215	47	3,0	1,1	66320	7320B	1	190297	150275	1900	2600	8,0
	250	58	5,0	2,5	86420	-	2	221505	185910	1700	2400	16,0
105	160	26	2,0	1,0	36121	B7021C	2	72243	60451	3000	4200	1,7

Размеры/Dimensions					Обозначение/ Designation		Эскиз №/Drawing #	Грузоподъемность/ Load rating		Макс. Скорость/ Limiting Speed		Вес/ Weight
d	D	B	r min	r1 min				C	C _o	Пластичная смазка/ Grease	Жидкая смазка/ Oil	
мм/mm					Россия/ Russia	ИСО/ ISO		Н/Н		мин ⁻¹ /min ⁻¹		кг/kg
105	160	26	2,0	1,0	46121	B7021E	2	62460	50631	3000	4200	1,720
110	140	16	1,0	1,0	1076822	-	2	16900	14400	3200	4400	0,455
	200	38	2,1	1,1	46222	B7222E	1	174000	135000	2600	3500	4,592
120	150	10	0,6	0,6	7076824	-	2	16000	14380	3000	4000	0,402
	150	10	0,6	0,6	7936824	-	1	15000	14000	1600	2000	0,379
	215	40	2,1	1,1	66224	7224B	1	165769	126361	1800	2500	6,254
130	1665	18	2,0	1,0	1736826	-	1	59340	60723	2700	3700	0,761
	200	33	2,0	2,0	116126	-	5	116970	123200	2400	3300	4,21
	200	33	2,0	2,0	276126	-	4	150000	118700	4000	5000	4,099
	200	33	2,0	1,0	46126	B7026E	1	127000	103000	2400	3300	3,26
140	175	18	1,1	0,6	1066828	-	1	36700	37800	3000	4000	0,912
	190	24	1,5	0,6	1036928	B71928C	1	75000	85000	2500	3500	1,722
	250	42	3,0	1,1	66228	7228B	1	176297	145808	1600	2000	9,064
150	270	45	3,0	1,1	46230	B7230E	1	233000	208000	1900	2600	12,88
160	200	13	0,6	0,6	7006832	-	1	26800	37150	2200	3000	0,868
	220	28	2,0	1,0	1046932	B71932E	2	46380	54730	2100	2900	3,398
180	320	52	4,0	1,5	36236	B7236C	1	299000	366900	1600	2200	11,785
190	225	14	1,0	0,5	7036638	-	1	27700	39000	1900	2650	0,909
	260	33	2,0	1,0	1046938	B71938E	1	160600	152400	1800	2400	5,21
200	360	58	4,0	1,5	36240	B7240C	1	333000	347000	1400	1900	28
202	230	8	0,6	0,6	7936840	-	1	17700	36600	1850	2500	0,499
203	254	25	4,0	2,0	66941	-	1	66016	71201	1500	2000	3,141
210	300	40	4,0	2,5	46742	-	2	222000	216000	1400	1900	8,83
220	270	24	1,5	1,5	1136844	-	1	84000	106700	1400	1900	2,588
320	480	74	4,0	1,5	46164	B7064E	1	418000	523000	1200	1400	46

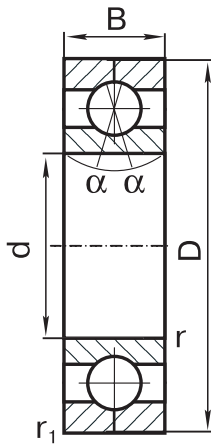

Эскиз 1
Drawing 1

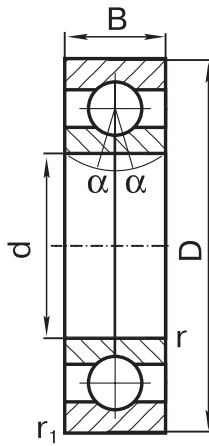

Эскиз 2
Drawing 2

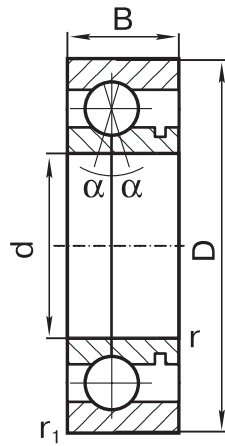

Эскиз 3
Drawing 3

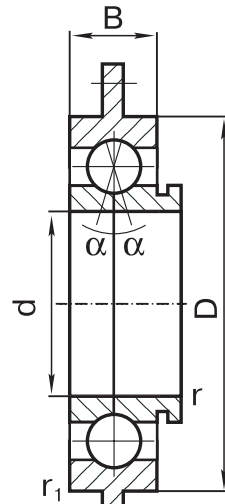

Эскиз 4
Drawing 4

Размеры/Dimensions					Обозначение/ Designation		Эскиз №/Drawing #	Грузоподъемность/ Load rating		Макс. Скорость/ Limiting Speed		Вес/ Weight
d	D	B	r min	r1 min				C	C _o	Пластичная смазка/ Grease	Жидкая смазка/ Oil	
мм/mm					Россия/ Russia	ИСО/ ISO		Н/Н		мин ⁻¹ /min ⁻¹		кг/kg
17	47	14	1,1	-	176303	QJ303	2	16100	8000	16000	20000	0,12
20	47	14	1,0	1,0	126204	-	2	11150	6940	14000	18000	0,129
	42	12	0,6	0,6	176104	QJ1004	2	10500	6300	12900	17700	0,0773
	52	15	1,1	1,1	176304	QJ304	2	17800	9000	14000	18000	0,177
25	47	12	0,6	0,6	176105	QJ1005	2	12000	6430	11000	15000	0,082
	52	15	1,0	1,0	126205	-	2	14800	7650	14000	17000	0,172
30	62	16	1,0	1,0	126206	-	2	20700	11000	13000	16000	0,249
	72	19	1,1	1,1	176306	QJ306	2	34300	19800	7800	10000	0,434
35	72	17	1,3	1,3	176207	QJ207	2	23200	16300	12000	15000	0,33
	72	17	1,3	1,3	126207	-	2	23200	16300	12000	15000	0,314
	80	21	1,5	1,5	176307	QJ307	2	40000	22500	10000	13000	1,03
38	68	20	1,0	1,0	126708	-	2	17000	12370	7500	10300	0,281
	90	23	1,8	1,8	126308	-	2	47000	30800	6100	8500	0,768
40	68	15	1,0	1,0	126108	-	2	17000	12370	7400	10200	0,266
	80	18	2,0	2,0	176208	-	2	36800	24700	6700	9150	0,439
	80	18	1,3	0,7	136208	-	2	36730	21300	9500	13000	0,459
	80	18	1,1	1,1	126208	-	2	32000	18600	10000	13000	0,49
45	85	19	1,1	1,1	116209	-	1	38800	27000	6150	8500	0,513
	75	16	1,0	1,0	176109	-	2	26060	16000	10000	13000	0,297
	85	19	1,1	1,1	126209	-	2	38700	23100	9600	12000	0,509
50	100	25	1,5	1,5	176309	QJ309	2	61400	37000	8000	10000	0,903
	90	20	1,1	1,1	126210	-	2	40500	30200	5700	7800	6,621
	110	27	2,0	2,0	176310	QJ310	2	71800	4400	6300	8000	1,17
55	100	21	1,5	1,5	116211	-	1	50700	37800	5200	7100	0,674
	100	21	1,5	1,5	126211	-	2	50300	37800	5200	7000	0,805
	100	21	1,5	1,5	176211	QJ211	2	50300	31500	8500	10000	0,752
	120	29	2,0	2,0	176311	QJ311	2	82800	51600	6000	7500	1,49
60	110	22	1,5	1,5	126212	-	2	46400	36100	7500	9500	0,861
	110	22	1,5	1,5	176212	QJ212	2	58000	36100	7500	9500	0,945
65	120	23	1,5	1,5	116213	-	1	63100	51600	4300	6000	1,127
	120	27	1,5	1,5	176213	QJ213	2	60200	48200	4300	5900	1,53
70	125	24	1,5	1,5	126214	-	2	75300	61200	4100	5600	1,38
	150	35	2,1	2,1	126314	-	2	120550	87400	3600	5000	3,97
	150	35	2,1	2,1	116314	-	1	113300	85200	3300	5000	3,279
	110	20	1,1	1,1	126114	-	2	46100	31700	7500	9000	0,835
75	150	35	2,1	2,1	176314	QJ314	2	122000	80000	4800	6000	3,332
	130	25	1,5	1,5	126215	-	2	75100	50400	6300	8000	1,5
85	190	43	3	3	126415	-	2	174300	142500	3000	4200	7,5
	130	23	1,3	1,3	126117	-	2	63700	57400	3700	5100	1,211
90	180	41	3,0	3,0	176317	QJ317	2	163000	120000	3200	4000	4,75
	160	30	2,0	2,0	126218	-	2	104000	88000	3200	4400	2,93
	160	30	2,0	2,0	176218	QJ218	2	111000	92610	3200	4400	2,841
95	190	43	1,5	1,5	176318	QJ318	2	186900	148300	2800	4000	6,51
	145	24	1,5	1,5	126119	-	2	66800	65800	3300	4600	1,523
	145	24	1,5	1,5	176119	QJ1019	2	60610	45130	5000	6300	1,47
	170	32	2,1	2,1	126219	-	2	125720	87490	5000	6300	3,59
	170	38,3	2,1	2,1	126719	-	3	125720	87490	5000	6300	3,91
100	130	23	1,1	1,1	1126919	-	3	39200	43600	3500	4900	0,892
	165	46	2,0	-	126820	-	2	104700	94300	3000	4150	3,466
	180	34	2,5	2,5	126220	-	2	141000	121000	3000	4000	3,89
	180	34	3,5	3,5	176220	-	2	141100	120960	2800	3900	3,87
	250	58	3,7	3,7	86420	-	2	221505	185910	1700	2400	16,0
	125	13	1,0	1,0	1126820	-	2	23000	20800	6000	8000	0,361
	165	30	2,0	2,0	1176720	-	2	105000	75100	5000	6300	2,7
105	215	47	3,0	3,0	176320	QJ320	2	213000	176000	2800	3600	7,74
110	160	38	2,0	-	126821	-	2	88800	85700	3000	4200	2,54
110	170	28	2,0	2,0	126122	-	2	92000	90500	2900	4000	2,6

Размеры/Dimensions					Обозначение/ Designation		Эскиз №/Drawing #	Грузоподъемность/ Load rating		Макс. Скорость/ Limiting Speed		Вес/ Weight
d	D	B	r min	r1 min				C	C _o	Пластичная смазка/ Grease	Жидкая смазка/ Oil	
мм/mm					Россия/ Russia	ИСО/ ISO		Н/Н		мин ⁻¹ /min ⁻¹		кг/kg
110	200	38	2,1	2,1	116222	-	1	167000	151000	2600	3500	5,828
	170	36	2,0	2,0	126722	-	2	92000	90500	2800	3900	2,78
	170	28	2,0	2,0	126122	-	2	96300	73500	3800	5600	2,6
	170	28	2,0	2,0	176122	-	2	96300	73500	5000	6300	2,211
	200	38	2,1	2,1	176222	QJ222	2	180000	140000	3200	4000	5,75
	200	45/38	1,8	2,5	176822	-	3	180000	140000	3200	4000	5,9
120	180	28	2,0	2,0	126124	-	2	93640	73460	4000	5000	2,67
	200	38	2,0	2,0	1176724	-	2	152000	114000	4000	5000	4,77
125	200	30	1,8	1,8	126825	-	2	131190	103440	3200	4300	3,925
130	165	18	1,3	1,3	1736826	-	1	59340	60723	2700	3700	0,761
	200	33	2,0	2,0	116126	-	1	116980	123270	2400	3300	4,21
	180	24	1,5	1,5	1126926	-	2	76060	65170	4000	5000	2,069
	200	33	2,3	-	116126	-	1	118000	93900	4000	5000	4,21
	200	33	2,0	2,0	176126	-	2	127000	103000	4000	5000	3,99
	230	40	3,0	3,0	176226	QJ226	2	192000	156000	2800	3400	8,19
	238/200	39/33	2,0	2,0	126126P1	-	3	126540	98000	4000	5000	5,348
	200	33	2,0	2,0	126126	QJ1026	2	148000	113440	4000	5000	3,99
	238/200	39/33	2,0	2,0	176126P5Y	-	3	148000	113440	4000	5000	5,08
	230	46	3,0	3,0	1176226	-	4	193000	153000	2000	2600	8,94
140	190	30/24	1,5	1,5	1126928	-	3	80000	72200	4300	6300	2,347
	210	33	2,0	2,0	126128	-	2	134000	109000	3200	4300	4,17
	210	33	2,0	2,0	176128	-	2	134000	109000	3200	4300	4,17
	210	39/33	2,0	2,0	126728	-	2	134000	109000	2600	3200	4,71
	250	42	3,0	3,0	176228	QJ228	2	221000	188000	2600	3200	8,26
	250	50	3,0	3,0	1176228	-	2	221000	183000	2000	2600	10,393
150	225	35	2,1	2,1	176130	-	2	142400	157250	2100	2900	5,3
160	240	38	2,1	2,1	126132	-	2	162000	137000	2600	3200	6,88
	240	38	2,5	-	176132	-	2	162000	137000	2600	3200	6,251
	290	48	3,0	3,0	176232	QJ232	2	272000	256000	2200	2800	15,3
170	230	33/28	2,0	3,0	1126934	-	3	117000	108000	3400	5000	3,8
	280	51	2,1	2,1	1176734	-	2	237000	215000	2600	3200	12,6
170	310	52	4,0	4,0	176234	QJ234	2	303000	300000	2000	2600	17,7
180	250	39/33	2,0	2,0	1126936	-	3	144920	130660	2000	2600	5,56
	320	52	4,0	4,0	126236	-	2	294390	291610	2000	2600	18,6
	320	52	4,0	4,0	176236	QJ236	2	280000	272000	2000	2600	17,8
190	260	33	2,0	2	1176938	-	2	150000	142000	2600	3200	5,91
	340	55	4,0	4,0	176238	QJ238	2	312000	319000	1600	2000	5,91
200	280	38	2,1	2,1	1176940	-	2	172000	163000	2600	3200	6,861
	310	51	2,1	2,1	176140	-	2	251000	245000	2000	2600	12,472
	360	58	4,0	4,0	176240	-	2	370000	400000	1600	2000	25,1
220	270	24	1,5	1,5	1136844	-	1	84000	106700	1400	1900	2,588
	340	56	3	3	176144	QJ1044	2	304600	414900	1400	1900	20,4
	300	44/38	2,1	2,1	1126944	-	3	176920	174980	1600	2000	9,23
320	400	38	2,1	2,1	1176864	-	2	194000	234000	1600	2000	11,83
360	460	46	4,0	4,0	176772	-	2	237700	291530	1000	1300	23,447
	470	40	2,1	2,1	176872	-	2	244700	300500	700	1000	17,73

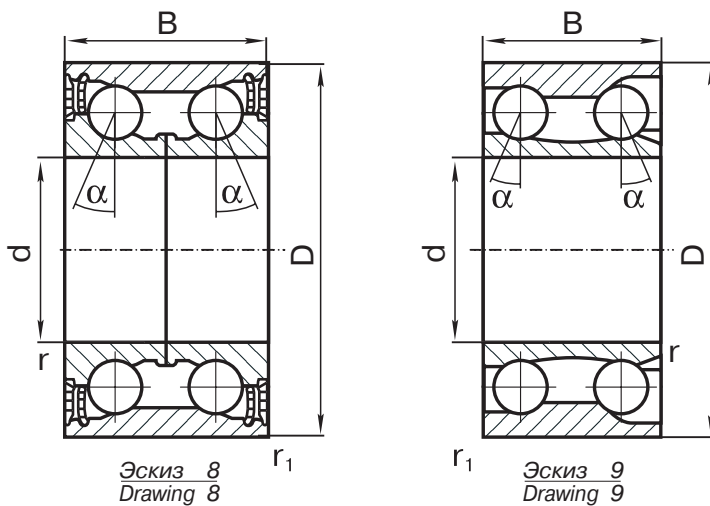
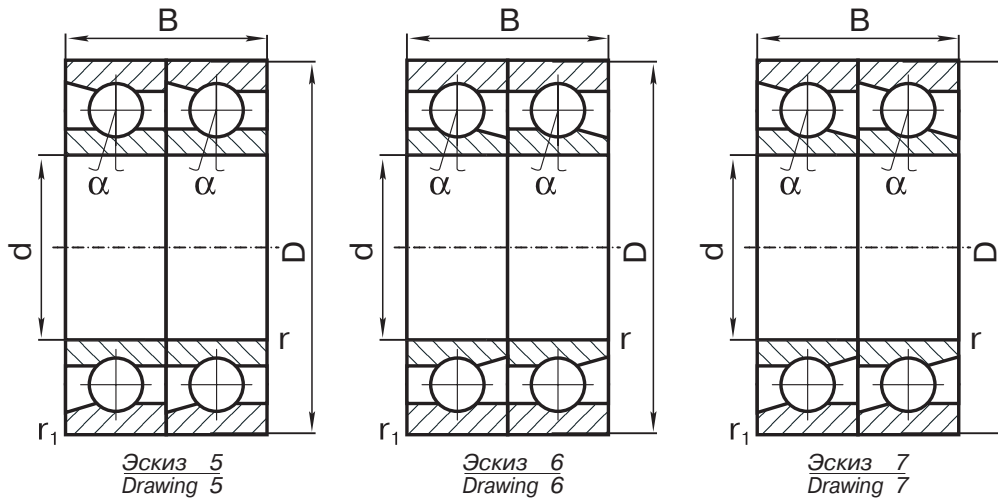
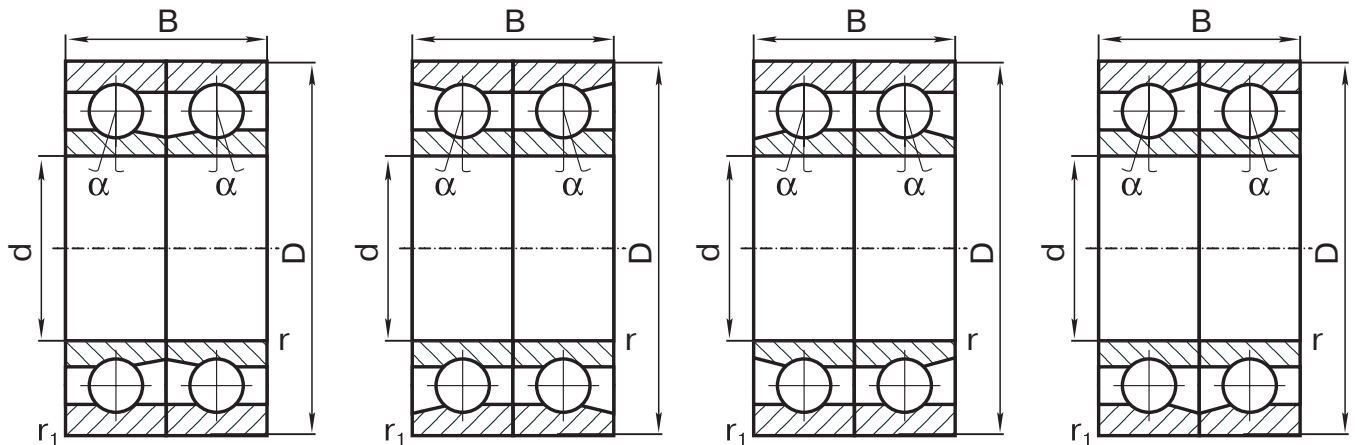

Размеры/Dimensions					Обозначение/ Designation		Эскиз №/Drawing #	Грузоподъемность/ Load rating		Макс. Скорость/ Limiting Speed		Вес/ Weight
d	D	B	r min	r1 min				C	C _o	Пластичная смазка/ Grease	Жидкая смазка/ Oil	
мм/mm					Россия/ Russia	ИСО/ ISO		Н/Н		мин ⁻¹ /min ⁻¹		кг/kg
12	28	16	0,3	0,2	436101	-	7	8780	4840	20000	26000	0,0448
	32	20	0,6	0,3	236201	7201C/DB	1	12080	6950	18000	25000	0,062
	32	20	0,6	0,2	436201	7201C/DT	6	11600	6600	20000	26000	0,062
15	28	14	2,0	0,3	1236902	-	2	2600	1600	18600	25500	0,034
	32	18	0,3	0,15	436102	-	6	10100	5900	16000	22000	0,0657
	35	22	0,6	0,3	236202	7202C/DB	1	13377	7822	1600	20000	0,09
	35	22	0,6	0,3	246202	-	1	13200	7300	16000	20000	0,0894
	35	12	0,6	0,3	446202	7202AC/DT	6	13200	7300	16000	20000	0,0894
17	40	24	0,6	0,3	246203	7203AC/DB	1	17300	10900	14000	19300	0,162
	30	14	0,3	0,1	1236903	71903C/DB	1	6591	3905	17000	23000	0,0372
	30	14	0,3	0,1	1436903	71903C/BG	6	6591	3905	17000	23000	0,0372
	35	20	0,3	0,15	236103	7003C/DB	1	10394	6120	15000	21000	0,0836
	35	20	0,3	0,15	436103	7003C/DT	6	10150	5900	16000	20000	0,0836
	35	20	0,3	0,15	446103	7003AC/DT	7	10000	5600	16000	20000	0,0836
	40	24	0,6	0,3	346203	7203AC/BG	3	16260	9889	14000	19300	0,113
	40	24	0,6	0,3	236203	7203C/DB	1	19500	12200	13000	18000	0,1254
	40	24	0,6	0,3	246203	7203AC/DB	1	17300	10100	13000	18000	0,162
	40	24	0,6	0,3	336203	-	3	15900	9550	13000	18000	0,113
20	40	24	0,6	0,3	436203	7203C/DT	6	15900	9550	13000	18000	0,113
	50	20	1,5	0,5	156704	-	2	20300	15300	8600	11400	0,197
	42	24	0,6	0,3	236104	7004C/DB	1	14531	9084	13000	18000	0,151
	47	28	0,3	0,3	236204	7204C/DB	1	25400	17900	12000	16000	0,202
	42	24	0,6	0,3	336104	7004C/BG	2	14531	9084	13000	18000	0,151
	42	24	0,6	0,3	436104	7004C/DT	7	14150	8770	16000	20000	0,151
	47	20,6	1,0	1,0	3056204У	-	9	20100	15600	12000	16400	0,17
	47	28	1,0	0,6	246204	7204AC/DB	2	25687	17000	12000	16500	0,202
25	47	28	1,0	0,6	436204	7204C/DT	5	22020	13430	12000	17000	0,198
	42	9	0,5	0,3	1036905	B71905C	2	8230	4441	12000	16000	0,0424
	42	18	0,5	0,3	1236905	-	1	13370	8880	12000	17000	0,0848
	47	24	0,6	0,3	236105	7005C/DT	1	15970	10600	11000	15300	0,152
	52	20,6	1,0	1,0	3056205	-	9	22200	18800	11300	14300	0,195
	47	30	0,6	0,6	416105	-	5	15500	12690	11000	15000	0,191
	47	24	0,6	0,3	436105	7004C/DT	6	15540	10240	12000	17000	0,165
	52	30	1,0	0,6	236205	7205C/DB	2	27200	18100	11000	16000	0,244
30	52	30	1,5	0,5	576205	-	6	28500	14600	10000	13000	0,254
	47	18	0,5	0,3	1436906	71906C/BG	6	29200	25500	10400	14300	0,021
	55	26	1,0	0,6	236106	7004C/DB	1	21460	15280	10000	13000	0,255
	55	26	1,1	0,6	436106	7004D/DT	6	21460	15280	10000	13000	0,256
	62	32	0,3	0,3	436206	7206C/DT	5	37800	29800	8700	12000	0,4
	60	37	0,6	0,3	256706	-	8	38000	30300	8900	12200	0,054
	62	32	0,6	0,6	446206	7206AC/DT	5	35600	27800	8700	12000	0,428
35	90	46	1,5	1,0	466406	-	5	74370	49620	4300	5800	1,66
	72	34	2,0	1,0	576207	-	6	27030	34700	7500	10300	0,604
	62	28	1,0	0,6	236107	7007C/DB	1	31930	23180	8250	11300	0,310
	62	28	1,0	0,6	336107	7007C/DB	3	31930	23180	8250	11300	0,310
	62	28	1,0	0,6	436107	7007C/DT	6	31100	22400	10000	13000	0,310
	72	34	1,1	0,6	236207	7207C/DB	1	46600	32170	9500	12000	0,580
39,685	72	34	1,1	0,6	436207	7207C/DT	4	8920	8220	9500	12000	0,58
	62	48	0,6	0,6	1246908	-	1	32300	41800	7800	10800	0,482
	80	36	1,3	0,7	236208	7208C/DB	2	54700	40900	9000	11000	0,72
	72	37	0,6	0,5	256908	-	8	58600	48200	7300	10000	0,57
	80	36	0,6	0,6	336208	-	3	54700	40900	9000	11000	0,734
	80	36	1,0	0,6	436208	7208C/DT	5	54700	40900	9000	11000	0,72
45	110	54	0,6	0,6	366408	-	3	116000	84600	4000	5000	2,636
	85	38	2,0	1,0	576209	-	6	27750	30250	6150	8500	0,871
	85	38	1,1	0,6	236209	7209C/DB	2	67900	51400	6150	8500	0,808

Размеры/Dimensions					Обозначение/ Designation		Эскиз №/Drawing #	Грузоподъемность/ Load rating		Макс. Скорость/ Limiting Speed		Вес/ Weight
d	D	B	r min	r1 min				C	C _o	Пластичная смазка/ Grease	Жидкая смазка/ Oil	
мм/mm					Россия/ Russia	ИСО/ ISO		Н/Н		мин ⁻¹ /min ⁻¹		кг/kg
45	85	38	1,1	0,6	436209	7209C/DT	5	67000	50300	8000	10000	0,808
	100	50	1,8	1,8	346309	-	4	99500	73950	6000	8000	1,74
	100	50	1,8	0,9	446309	-	5	99500	73950	6000	8000	1,74
46,035	57,15	12,7	0,2	0,2	336909	-	4	9224	9190	6000	8000	0,0584
50	80	32	1,0	0,6	236110	7010C/DB	1	41910	33650	6150	8500	0,553
	80	32	1,0	0,6	436110	2X7010CBG	6	25070	22600	6150	8500	0,553
	80	32	1,0	0,6	246110	7010AC/DB	1	38240	30240	8000	10000	0,5492
	90	40	1,1	0,6	236210	7210C/DB	2	70200	54200	8000	10000	0,893
	90	40	1,1	0,6	436210	7210C/DT	5	70200	54200	8000	10000	0,893
	110	54	2,3	2,3	326310	-	5	104500	88200	3750	5000	2,6
55	120	58	2,0	1,0	446311	-	7	131000	103000	5000	7000	2,84
	100	42	1,5	1,5	236211	7211C/DB	1	77670	63290	5000	7000	1,61
	120	58	2,3	2,3	346311	-	4	131000	103000	5000	6300	2,84
65	100	36	1,1	0,6	236113	7013C/DB	1	62070	54840	5000	6500	0,881
	100	36	1,1	0,6	436113	7013C/DT	6	60220	52970	5000	6300	0,8804
70	180	84	3	3	466414	-	5	246500	234500	2400	3200	11,9
85	180	82	3	1,1	466317	2X7317BG	5	282460	267740	2300	3100	9,0
90	125	54	1,1	0,6	1246918	-	1	75000	115000	3700	5100	1,85
	125	36	1,1	0,6	1236918	-	1	611120	31160	5000	6300	1,23
	140	48	1,5	1,0	436118	7018C/DB	7	104710	96720	3200	4300	2,288
100	140	40	1,1	0,6	1236920	-	1	78790	81900	3200	4300	1,74
	180	68	2,1	1,1	266220	7220BBG	2	260100	237340	2150	2950	7,728
	215	94	3,0	1,1	466320	2x7320BG	7	368190	392340	1900	2600	16
110	200	76	2,1	1,1	446222	2X7222BG	5	284000	323600	2600	3500	9,184
140	200	66	2,0	1,0	446126	2x7026BG	5	209225	208920	2400	3300	6,52
	250	84	3,0	1,5	466228	2X7288BG	2	286500	378120	1500	2000	18,128
	175	36	1,1	0,6	1266828	-	2	59400	96800	2540	3500	1,83
	250	84	3	1,1	466228	7228BG	7	341620	360460	1540	2100	18,128
160	220	84	2,0	2,0	1246932	-	1	161600	252400	2100	2900	8,73
	220	56	2,3	2,3	1246932	-	1	161870	189870	1400	1900	5,82
220	270	24	1,5	1,5	1136844	-	1	84000	106700	1400	1900	2,588
320	480	148	4	1,5	246164	7064AC/DB	2	735700	1162960	1000	1400	91,9

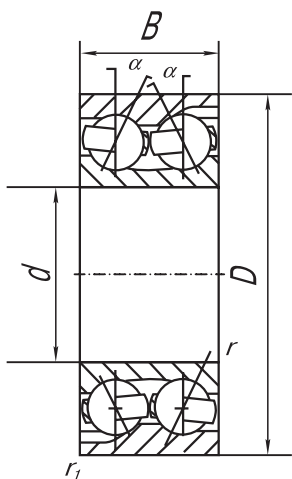

Эскиз 1
Drawing 1

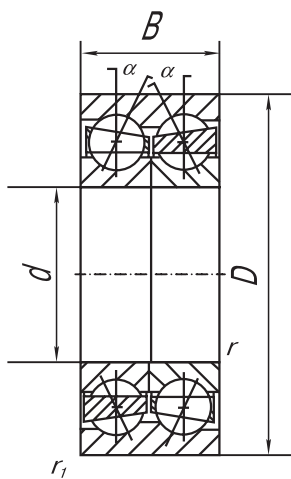

Эскиз 2
Drawing 2

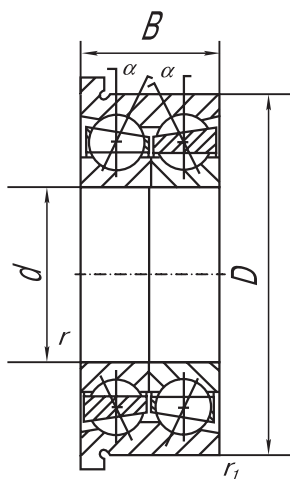

Эскиз 3
Drawing 3

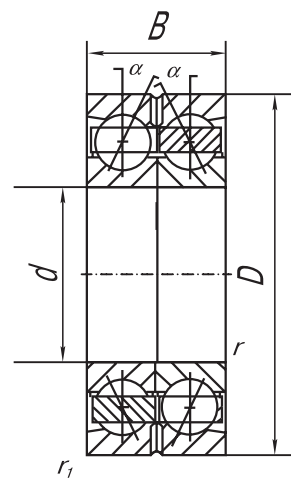

Эскиз 4
Drawing 4

Размеры/Dimensions					Обозначение/ Designation		Эскиз №/Drawing #	Грузоподъемность/ Load rating		Макс. Скорость/ Limiting Speed		Вес/ Weight
d	D	B	r min	r1 min				C	C _o	Пластичная смазка/ Grease	Жидкая смазка/ Oil	
мм/mm					Россия/ Russia	ИСО/ ISO		Н/Н		мин ⁻¹ /min ⁻¹		кг/kg
20	47	20,6	0,6	0,7	3056204У	3204	1	21200	15600	12000	16400	0,17
25	52	20,6	1,0	1,0	3056205	3205	1	23450	18900	10400	14300	0,195
30	62	23,8	0,7	0,6	3056206	3206	1	33600	28200	8700	12000	0,314
35	72	27,00	1,0	1,1	3056207	3207	1	53150	42800	7500	10300	0,5197
55	100	33,3	1,8	0,9	3156211	-	2	65300	65100	5200	7100	1,21
65	100	35	1,3	0,7	4286113У	-	4	49700	56500	4800	66700	0,923
90	140	37	1,1	0,5	3166118У	-	3	101300	124000	3800	4800	2,28
480	600	90	3,0	3,0	3156896	-	2	496700	1152400	740	1000	60,2
160	200	30	1,3	1,3	3286832	-	2	57500	100100	2200	3110	2,29
240	300	45	2,3	1,1	3286848	-	2	152300	278800	1500	2000	7,35
280	350	52	2,3	2,3	3286856	-	2	191500	355600	1300	1700	12,4

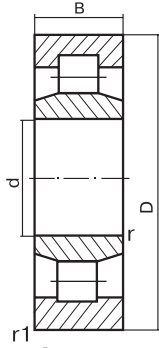

Эскиз 1
Drawing 1

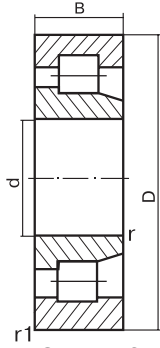

Эскиз 2
Drawing 2

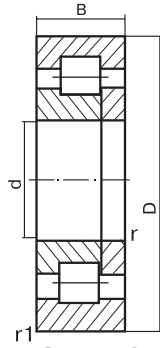

Эскиз 3
Drawing 3

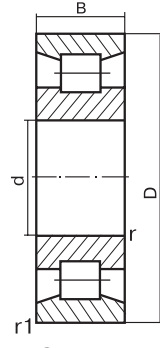

Эскиз 4
Drawing 4

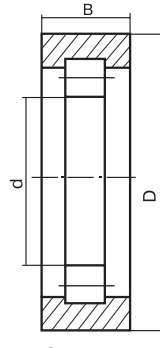

Эскиз 5
Drawing 5

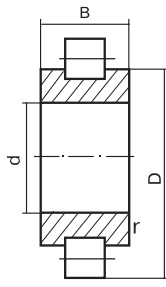

Эскиз 6
Drawing 6

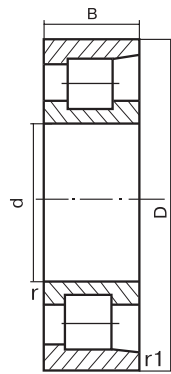

Эскиз 7
Drawing 7

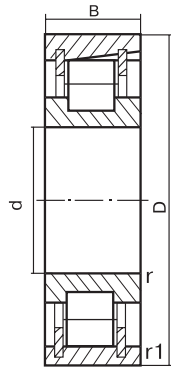

Эскиз 8
Drawing 8

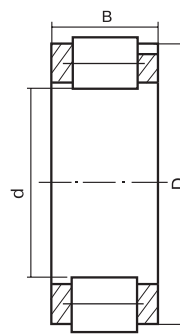

Эскиз 9
Drawing 9

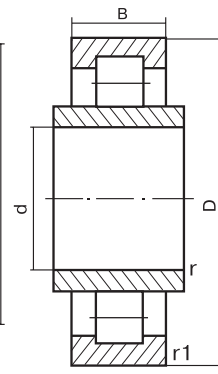

Эскиз 10
Drawing 10

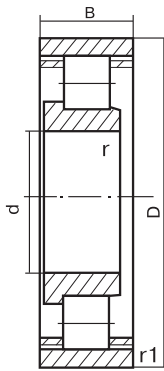

Эскиз 11
Drawing 11

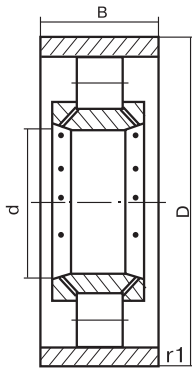

Эскиз 12
Drawing 12

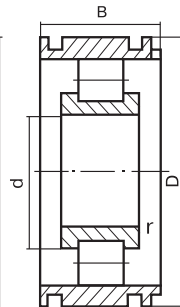

Эскиз 13
Drawing 13

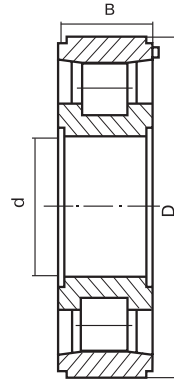

Эскиз 14
Drawing 14

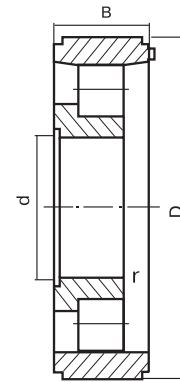

Эскиз 15
Drawing 15

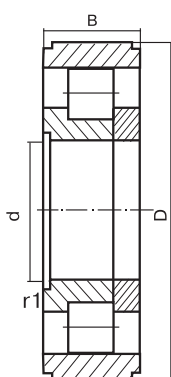

Эскиз 16
Drawing 16

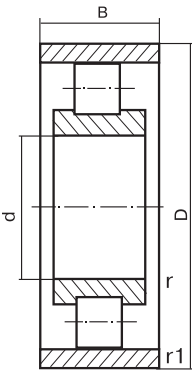

Эскиз 17
Drawing 17

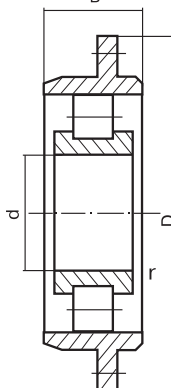

Эскиз 18
Drawing 18

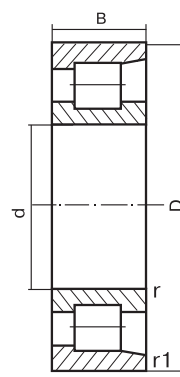

Эскиз 19
Drawing 19

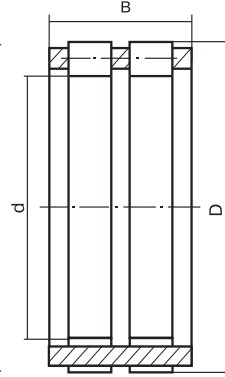

Эскиз 20
Drawing 20

Размеры/Dimensions					Обозначение/ Designation		Эскиз №/Drawing #	Грузоподъемность/ Load rating		Макс. Скорость/ Limiting Speed		Вес/ Weight
d	D	B	r min	r1 min	Россия/ Russia	ИСО/ ISO		C	C _o	Пластичная смазка/ Grease	Жидкая смазка/ Oil	
мм/mm										Н/Н		
8	19	8	0,3	-	292073	-	5	5300	2600	30000	34000	0,0143
10	22	11,3	0,3	-	292088	-	5	6200	3000	25000	29000	0,022
	30	9	0,6	0,3	42200	-	2	6600	2900	17500	20000	0,038
12	37	17	0,7	0,7	492701	-	3	19600	19100	14300	16300	0,114
14,6	28	15,6	-	0,3	432902	-	20	10200	8100	16400	18800	0,043
	28	8	-	0,3	192905	-	9	12200	9900	10400	11900	0,043
15	35	31,6	0,5	0,7	832901	-	18	22100	27700	14500	16700	0,168
	35	11	0,7	0,3	32202	NU202	1	8970	4250	19000	24000	0,0556
	35	11	0,7	0,3	42202	NJ202	2	8970	4250	19000	24000	0,057
	35	11	0,7	0,7	702202	-	4	10850	5500	12000	14000	0,0474
	35	15	1,1	-	502302	-	6	13970	7720	13000	16000	0,606
	42	13	1,0	0,6	12302	NF302	7	13700	7720	13000	16000	0,104
	42	13	1,1	0,7	32302	NU302	1	13700	7720	13000	16000	0,1096
	42	13	1,1	-	732302	-	1	17000	8940	12000	14000	0,103
	35	11	0,6	0,6	292202	RNU202	5	8670	4250	19000	24000	0,044
35	14	0,7	-	292502	-	5	12130	6260	13000	16000	0,0547	
16	40	12	1,5	0,8	2902	-	4	9870	4630	16000	20000	0,0857
17	40	12	0,6	0,3	32203	NU203	1	10800	5200	17000	20000	0,084
	40	12	0,7	0,3	42203	NJ203	2	10800	5200	17000	20000	0,0913
20	47	14	1,0	1,0	42204	NJ204	2	14600	11900	11900	11900	0,12
	47	14	0,6	1,0	32204	NU204	1	14600	11900	10500	11900	0,117
	47	14	1,0	3,0	2204	N204	4	14600	11900	10500	11900	0,127
	52	15	1,1	1,1	12304	NF304	7	26100	19800	9700	11100	0,18
	46	15	1,3	-	652304	-	9	25700	19100	10600	12100	0,123
	44	14	1,0	1,0	692204	-	3	18000	16200	10900	12500	0,134
	36,5	12	0,6	-	502104	-	6	11320	5550	13000	16000	0,055
	42	12	0,6	0,6	2104	N1004	4	8800	4700	16000	20000	0,087
	42	16	1,1	-	502704	-	6	11320	5550	10000	11500	0,104
	47	14	1,0	0,6	12204	NF204	7	14700	7350	15000	18000	0,117
	47	18	1,0	0,6	42504	NJ2204	2	20100	10800	10700	12300	0,167
	52	15	1,1	0,6	102304	-	8	20500	10400	9700	11000	0,166
52	15	1,1	1,1	42304	NJ304	2	20000	15900	9700	11000	0,185	
20,6	33,6	26,5	-	-	252904	-	20	30770	19080	12000	14000	0,103
22,9	40	12	0,7	-	292203	RNU203	5	10800	5200	17000	20000	0,0558
25	52	18	0,6	0,6	42505	NJ2205	2	25860	23500	9100	10400	0,158
	80	21	1,5	1,5	492405	-	3	52700	47700	6700	7700	0,668
	52	20,5	1,1	0,7	102805	-	8	19700	18000	9090	10400	0,178
	52	15	1,0	1,0	2205	N205	4	16800	8800	12000	15000	0,1539
	52	15	1,0	0,6	12205	NF205	7	16800	8800	12000	15000	0,163
	52	15	1,0	0,6	92205	NUP205	3	16800	8800	12000	15000	0,152
	52	15	1,0	0,6	102205	-	8	19780	10860	10860	10500	0,142
	52	15	1,0	0,6	32205	NU205	1	16800	8800	12000	15000	0,14
	52	15	1,1	0,7	42205	NJ205	2	16800	8800	12000	15000	0,147
	62	17	1,1	1,1	42305	NJ305	2	44000	26000	9500	12000	0,261
	55	18	1,0	0,6	92705	-	3	29000	17100	12000	15000	0,207
27	47	14	1,1	-	292204	RNU204	5	14700	7350	15000	18000	0,0999
30	53,5	16	1,0	-	652206	-	9	22500	20100	8400	9600	0,158
	68	19	1,1	1,1	692306	-	3	44180	44350	7100	8200	0,4
	42	29,5	-	-	252806	-	20	39330	26700	9700	11000	0,086
	53,5	16	1,1	-	502206	-	6	18890	9550	10000	13000	0,1446
	55	13	1,0	0,6	32106	NU1006	1	17900	7850	12000	15000	0,146
	62	16	1,0	0,6	32206	NU206	1	22400	12000	10000	13000	0,217
	62	16	1,1	1,1	42206	NUP206	3	22400	12000	10000	13000	0,2251
	62	16	1,1	0,7	92206	NUP206	3	22400	12000	10000	13000	0,225
	62	16	1,1	-	542206	-	2	30670	18140	7500	8500	0,2254
	62	20	1,1	1,1	32506	NU2206	1	31900	19000	9500	12000	0,3025
62	20	1,1	0,6	92506	NUP2206	3	31900	19000	9500	12000	0,2912	

Размеры/Dimensions					Обозначение/ Designation		Эскиз №/Drawing #	Грузоподъемность/ Load rating		Макс. Скорость/ Limiting Speed		Вес/ Weight	
d	D	B	r min	r1 min				C	C _o	Пластичная смазка/ Grease	Жидкая смазка/ Oil		
мм/mm					Россия/ Russia	ИСО/ ISO		Н/Н		мин ⁻¹ /min ⁻¹		кг/kg	
30	62	20	1,1	0,7	42506	NJ2206	2	31900	19000	9500	12000	0,310	
	72	19	1,1	1,1	2306	N306	4	36900	20000	8500	10000	0,435	
	72	19	1,3	1,3	32306	NU306	1	36900	20000	8500	10000	0,3814	
	72	19	1,3	1,3	42306	NJ306	2	36900	20000	8500	10000	0,388	
	72	27	1,3	1,3	42606	NJ2306	2	50100	29000	8000	9500	0,706	
32	46	32	-	-	252906	-	20	21900	3900	9000	10200	0,211	
	52	15	1,1	-	292205	RNU205	5	16800	8800	12000	15000	0,1184	
33	53	32	-	-	252807	-	20	35600	60800	8130	9300	0,181	
34	62	17	-	1,1	292305	-	5	37500	33400	7300	8300	0,199	
35	80	21	1,5	1,5	42307	NJ307	2	41700	37600	7000	6100	0,602	
	61,8	17	0,6	-	642207	-	9	33250	30700	7200	8300	0,201	
	55	10	0,3	0,6	1002907	-	4	11960	6600	10000	13000	0,093	
	55	25	-	-	822707	-	9	53100	32300	8000	9000	0,155	
	55	50	-	-	252907	-	20	91060	64700	8000	9000	0,209	
	62	14	1,0	0,6	32107	NU1007	1	21600	12200	10000	13000	0,1971	
	72	17	1,1	0,6	32207	NU207	1	31900	17600	9000	11000	0,349	
	72	17	1,3	0,7	42207	NJ207	2	31900	17600	9000	11000	0,376	
	72	17/23	1,3	0,7	672207	-	10	35420	20120	9000	11000	0,373	
	72	23	2,0	1,0	12507	NF2207	7	47300	29000	8500	10000	0,430	
40	80	21	1,1	1,1	32307	NU307	1	44600	27000	6000	7000	0,524	
	80	31	1,8	1,3	42607	NJ2307	2	58300	38000	7000	8500	0,848	
	36	50	15,5	-	-	822907	-	9	25070	14140	8000	9000	0,046
	36,5	55	13	1,1	-	292106	-	5	17900	7850	12000	15000	0,103
	38,5	62	16	1,1	-	292206	RNU206	5	22400	12000	10000	13000	0,1635
	38,6	58	48	-	-	252808	-	20	95170	68200	7000	8500	0,321
	40	65	13	0,3	0,6	2808	-	4	16400	15600	6700	7600	0,187
		77,5	23	1,1	1,1	592708	-	3	73500	84100	6000	6800	0,515
		54	40	-	-	252908	-	20	73905	53900	7400	8500	0,200
		62	12	0,3	0,7	1002908	-	4	23460	15190	9500	12000	0,159
		68	15	1,0	0,6	32108	NU1008	1	25100	14600	6500	7400	0,263
		77,5	23	1,8	0,6	502308	-	6	53600	30460	6700	8000	0,360
		80	18	1,1	1,1	12208	NF208	7	41800	24800	8500	10000	0,456
		80	18	1,1	1,1	32208	NU208	1	41800	24000	8500	10000	0,430
		80	18	1,3	1,3	42208	NJ208	2	41800	24000	8500	10000	0,437
		80	18	1,3	-	732208	-	1	49930	30300	6000	7000	0,447
80		23	1,3	1,3	32508	NU2208	1	56100	35000	7500	9000	0,556	
90		23	1,5	1,5	12308	NF308	7	56100	32500	6700	8000	0,670	
90		23	1,5	1,5	32308	NU308	1	56100	32500	6700	800	0,754	
90		23	1,5	1,5	102308	-	8	69600	43150	2000	2500	0,696	
90		23	1,5	1,5	2308	N308	4	56100	32500	6700	8000	0,630	
90	23	1,8	-	42308	NJ308	2	80900	44500	6700	8000	0,702		
110	27	2,3	-	42408	NJ408	2	96800	57000	6000	7000	1,42		
42	72	19	1,3	-	292306	-	5	36900	20000	8500	10000	0,2785	
43,6	72	17	1,3	-	292207	RNU207	5	31900	17600	9000	11000	0,274	
45	115,2	29	2,0	2,0	692409	-	4	99900	92100	4400	5000	1,65	
	85	19	1,1	1,1	102209	-	8	53800	58080	5400	6200	0,492	
	75	16	1,0	0,6	32109	NU1009	1	31400	17600	9000	11000	0,300	
	85	19	1,1	0,5	322209	-	4	54260	33840	7500	9000	0,452	
	85	19	1,1	1,1	2209	N209	4	41100	23370	7500	9000	0,429	
	85	19	1,1	1,1	32209	NU209	1	44000	25500	7500	9000	0,4897	
	85	19	1,3	1,3	42209	NJ209	2	44000	25500	7500	9000	0,5041	
	85	23	1,1	1,1	32509	NU2209	1	59400	38000	7000	8500	0,668	
	85	23	1,1	1,1	42509	NJ2209	2	59400	38000	7000	8500	0,668	
100	25	2,5	2,5	32309	NU309	1	69200	65600	4800	5500	1,03		
46,2	80	31	1,8	-	292607	-	5	58300	38000	7000	8500	0,65	
48	68	52	-	-	252910	-	20	109400	81800	6000	7000	0,403	
50	80	16	1,0	0,6	2110	N1010	4	30800	17600	8500	10000	0,333	

Размеры/Dimensions					Обозначение/ Designation		Эскиз №/Drawing #	Грузоподъемность/ Load rating		Макс. Скорость/ Limiting Speed		Вес/ Weight
d	D	B	r min	r1 min				C	C _o	Пластичная смазка/ Grease	Жидкая смазка/ Oil	
мм/mm					Россия/ Russia	ИСО/ ISO		Н/Н		мин ⁻¹ /min ⁻¹		кг/kg
50	80	16	1,0	0,6	32110	NU1010	1	30800	17600	8500	10000	0,31
	80	18	1,3	-	292208	-	5	41800	24000	8500	10000	0,326
	90	20	1,3	1,3	32210	NU210	1	45700	27500	7000	8500	0,5576
	100	21	2,5	2,5	2710	-	4	54300	32670	6300	8000	0,742
	110	27	2,3	2,3	32310	NU310	1	110000	70500	5600	6700	1,145
	130	31	3,5	3,5	32410	NU410	1	125200	119000	3890	4400	2,29
50,5	68	12	0,6	-	1292909	-	5	19150	11400	6000	7000	0,230
52	75	16	1,1	-	292109	-	5	38600	24240	9000	11000	0,233
	85	16	1,5	1,5	2910	-	4	32500	18890	8000	10000	0,325
52,5	77,5	32	-	-	822710	-	20	108000	121500	5400	6200	0,354
	77,5	61	-	-	252710	-	20	168900	134700	5000	6200	0,712
55	120	29	2,0	2,0	32311	NU311	1	102900	101250	4000	4600	1,81
	100	21	1,1	1,5	2211	N211	4	53500	56500	4500	5200	0,729
	81,5	18	1,1	-	502111	-	6	41900	26000	4800	5500	0,330
	85	19	1,3	-	292209	RNU209	5	44000	25500	7500	9000	0,392
	85	23	1,3	-	292509	-	5	59400	38000	7000	8500	0,416
	90	18	1,1	1,0	2111	N1011	4	34700	23600	7500	9000	0,484
	90	18	1,1	1,0	32111	NU1011	1	34700	23600	7500	9000	0,38
	100	21	1,1	1,3	32211	NU211	1	56100	34000	6300	7500	0,756
	100	21	1,5	1,1	102211	-	8	56100	34000	1600	2000	0,645
57,5	80	16	1,1	-	292110	-	5	30800	17600	8500	10000	0,235
58,5	100	25	2,5	-	292309	RNU309	5	69200	67000	5000	4400	0,836
60	127	33,1	2,5	-	752412	-	9	163900	161700	3700	4300	1,867
	79	13	1,1	-	1502912	-	6	23000	14500	5000	6000	0,183
	85	13	0,7	1,1	1002912	-	4	25300	16500	6300	8000	0,248
	97,5	22	1,8	-	502212	-	6	64400	43000	5600	6700	0,613
	100	22	1,1	1,0	2812	-	4	51960	32630	5600	6700	0,721
	110	22	1,5	1,5	2212	N212	4	70600	44750	5600	6700	0,9467
	110	22	1,8	1,8	32212	NU212	1	64400	43000	5600	6700	0,965
	110	22	1,8	1,8	42212	NJ212	2	64400	43000	5600	6700	0,989
	110	22	1,8	-	802212	-	4	83420	55840	5600	6700	0,856
	110	28	1,5	1,5	42512	NJ2212	2	93500	68000	5300	6300	1,150
	110	28	1,8	1,8	32512	NU2212	1	93500	68000	5300	6300	1,140
	110	28	1,8	1,8	92512	NUP2212	3	93500	68000	5300	6300	1,178
	130	31	2,5	-	42312	NJ312	2	123000	76500	4800	5600	1,972
	150	35	3,5	3,5	12412	NF412	7	168000	106000	4300	5000	3,51
	150	35/38	2,1	2,1	42712	-	11	182000	112000	3000	3500	0,695
	150	35	2,5	2,5	32412	NU412	1	152570	92970	5300	5000	3,08
	150	35	2,5	2,5	42412	NJ412	2	168000	106000	4300	5000	3,42
150	35	2,5	2,5	92412	NUP412	3	168999	106000	4300	5000	3,43	
	110	22	1,5	1,5	802212	-	20	78080	89800	4100	4700	0,86
60,4	90	20	1,3	-	292210	-	5	45700	27500	7000	8500	0,4349
63,5	90	18	1,3	-	292111	-	5	34700	23600	7500	9000	0,2698
65	120	23	1,5	1,5	42213	NJ213	2	76100	83600	3800	4300	1,28
	120	23	1,5	1,5	32213	NU213	1	72700	78700	3800	4300	1,09
	100	18	1,1	1,0	2113	N1013	4	38000	26500	6300	7500	0,547
	100	18	1,1	1,0	32113	NU1013	1	38000	26500	6300	7500	0,5038
	110	27	2,3	-	292310	-	5	88000	52000	5600	5700	1,03
	120	23	1,5	1,5	32213	NU213	1	76500	51000	5300	6300	1,09
66	88	13	-	0,5	802913	-	20	35500	45900	4500	5200	0,367
66,5	100	21	1,5	-	292211	RNU211	5	54100	32700	4500	5000	0,575
69	95	18	-	0,5	192912	-	9	40100	41700	4300	4900	0,58
70	88,5	16	1,1	-	502714	-	6	27950	19250	4000	5000	0,241
	100	16	1,1	0,7	1032914	-	1	44830	29060	4000	5000	0,430
	110	20	1,1	1,0	32114	NU1014	1	56100	36000	6000	7000	0,79
	110	20/26	1,1	1,0	272114	-	12	56100	36000	6000	7000	0,844
	125	24	1,5	1,5	2214	N214	4	79200	51000	5000	6000	1,370

Размеры/Dimensions					Обозначение/ Designation		Эскиз №/Drawing #	Грузоподъемность/ Load rating		Макс. Скорость/ Limiting Speed		Вес/ Weight
d	D	B	r min	r1 min				C	C _o	Пластичная смазка/ Grease	Жидкая смазка/ Oil	
мм/mm					Россия/ Russia	ИСО/ ISO		Н/Н		мин ⁻¹ /min ⁻¹		кг/kg
70	125	24	1,8	1,8	32214	NU214	1	79200	51000	5000	6000	1,307
	180	42	3,0	3,0	32414	NU414	1	229000	163000	3600	4300	5,48
72	110	22	-	1,5	292712	-	5	65800	68600	4390	3800	0,723
73,5	110	22	1,8	-	292212	-	5	64400	43000	5600	6700	0,735
75	105	16	0,7	1,1	1002915	-	4	30800	38500	4000	4400	0,487
	115	20	1,1	1	32115	NU115	1	55500	37000	3700	4200	0,821
76	100	16	1,0	-	1292914	-	5	44400	29000	4000	4500	0,339
77	130	31	3,5	-	292312	-	5	108000	108000	3400	3900	1,8
79,6	120	23	-	1,5	292213	-	5	72200	79600	3500	4000	0,804
80	110	20	1,3	-	292114	-	5	56110	36000	5000	6300	0,535
	110	16	0,7	1,1	1032916	NU1916	1	35500	45000	3700	4200	0,493
	125	22	1,1	1,0	32116	NU1016	1	66000	44000	5300	6300	1,06
	140	26	3,0	3,0	92216	NUP216	3	106000	68000	4500	5300	1,850
	140	26	2,0	2,0	2216	N216	4	106000	68000	4500	5300	1,77
	140	26	2,3	2,3	32216	NU216	1	106000	68000	4500	5300	1,574
	140	26	2,3	2,3	42216	NJ216	2	106000	68000	4500	5300	1,83
	170	39	2,5	2,5	32316	NU316	1	182650	117280	3600	4300	4,155
	170	39	2,5	2,5	42316	NJ316	2	190000	125000	3600	4300	4,6
200	48	3,0	3,0	32416	NU416	1	303000	200000	3200	3800	8,71	
82	122	19	2,5	2,5	2916	-	4	48730	32930	4000	5000	0,696
	122	19	1,5	1,5	32916	-	1	48730	32930	4000	5000	0,761
	122	30/19	1,5	1,5	672916	-	10	48730	32930	4000	5000	0,988
85	120	18	1,3	1,1	1032917	-	1	49320	34340	4000	5000	0,6
	120	22/18	1,1	1,1	1672917	-	10	35480	24030	4000	5000	0,729
	130	22	1,1	1	32117	NU1017	1	62500	41800	3200	4000	1,136
	180	41	3,0	3,0	2317	M317	4	207000	133300	3400	4000	4,56
	180	41	3,0	3,0	32317	NU317	1	260810	173730	3400	4000	5,561
90	108,5	13	1,1	-	1502818	-	6	26970	20500	3400	4000	0,243
	122	18/22	1,1	1,1	2272918	-	17	40880	30040	3400	4000	0,71
	140	24	1,5	1,1	2118	-	4	80900	56000	4800	5600	1,30
	140	24	1,5	1,5	32118	NU1018	1	80900	56000	4800	5600	1,4
	140	30/24	1,8	1,3	672118	-	10	80900	56000	4800	5600	1,478
	143	30	2,3	-	502218	-	6	142000	100000	3800	4500	1,73
	160	30	2,0	2,0	2218	N218	4	142000	105000	3800	4500	2,32
	160	30	2,3	2,3	32218	NU218	1	142000	105000	3800	4500	2,601
	160	30	2,3	-	42218	NJ218	2	142000	105000	3800	4500	2,82
	160	30	2,3	2,3	92218	NUP218	3	142000	105000	3800	4500	2,809
	160	30	2,3	3	802218	-	4	176000	121000	3800	4500	2,366
	160	40/30	2,3	2,3	672518	-	10	142000	105000	3800	4500	2,66
	180	28,7/30	2,3	-	492718	-	3	223400	157720	2600	3000	3,601
225	54	5,0	5,0	12418	NF418	7	385000	260000	2800	3400	11,90	
91,5	125	22	1,3	-	292116	-	5	66000	44000	5300	6300	0,797
94,9	180	33	1,0	3,0	792919	-	16	183300	210400	2500	2910	3,493
95	180	30	3,0	2,3	552919	-		230600	275000	2500	2900	3,63
	130	22	1,1	1,1	1002919	-	4	51100	37000	3100	3600	0,827
	130	18/22	1,1	-	272719	-	12	51420	40400	3100	3600	0,91
	130	22/18	1,1	1,1	2672919	-	10	51150	36980	3100	3600	0,851
	145	24	1,5	1,1	32119	NU1019	1	84200	58500	4500	5000	1,613
	145	30/24	1,5	1,1	2672119	-	10	84200	58500	4500	5000	1,685
	170	32	2,5	2,5	32219	NU219	1	165000	112000	3600	4300	2,79
	170	32	2,5	2,5	42219	NJ219	2	165000	112000	3600	4300	2,93
	170	32	2,5	2,5	92219	NUP219	3	165000	112000	3600	4300	3,02
180	33/30	2,3	2,3	672719	-	10	188130	126180	2500	3000	3,29	
95,3	140	26	2,3	-	292216	-	5	106000	68000	4500	5300	1,37
100	140	20	1,3	1,1	1032920	-	1	56800	47000	3200	4000	0,881
	150	24	1,5	1,1	32120	NU1020	1	85000	62000	4300	5000	1,62
	160	34	2,5	-	502220	-	6	183000	112000	2800	3500	2,65

Размеры/Dimensions					Обозначение/ Designation		Эскиз №/Drawing #	Грузоподъемность/ Load rating		Макс. Скорость/ Limiting Speed		Вес/ Weight	
d	D	B	r min	r1 min				C	C _o	Пластичная смазка/ Grease	Жидкая смазка/ Oil		
мм/mm					Россия/ Russia	ИСО/ ISO		Н/Н		мин ⁻¹ /min ⁻¹		кг/kg	
100	180	34	2,1	2,1	322220	-	4	183000	114000	3000	3500	3,416	
	180	34	2,1	2,1	2220	N220	4	183000	125000	3400	4000	3,517	
	180	34	2,5	2,5	32220	NU220	1	183000	125000	3400	4000	3,748	
	180	34	2,5	2,5	92220	NUP2206	3	183000	125000	3400	4000	4,28	
	180	34	2,5	2,5	142220	-	3	183000	125000	3400	4000	4,02	
105	180	46	2,1	2,1	42520	NJ2220	2	271200	349300	2500	2800	5,48	
	140	20/30	1,0	1,1	1672920	-	10	52200	67800	2900	3300	1,160	
	140	20/24	1,1	-	272721	-	12	54030	43090	3000	3500	1,08	
	160	26	2,0	1,1	32121	NU1021	1	101000	72500	4000	4800	2,049	
105,023	190	36	2,5	2,5	32221	NU221	1	201000	137000	3200	3800	4,792	
107	190	36	3,5	1,1	92721	-	3	204590	141950	3200	3800	4,792	
110	160	30	2,3	-	292218	-	5	134730	87400	3800	4500	1,88	
	140	19	1,1	-	2002822	-	4	39610	30880	2800	3200	0,75	
	140	19	1,1	-	272822	-	4	54930	45790	2800	3200	0,789	
	140	19/30	1,0	1,0	4272822	-	17	54930	45790	2800	3200	0,824	
	150	20	1,1	1,1	2672922	-	10	71200	54400	2700	3000	1,15	
	150	28	1,0	1,0	2002922	-	17	71200	54400	2700	3000	1,438	
	170	28	2,0	1,1	32122	NU1022	1	128000	88000	3800	4500	2,335	
	170	36/33	2,0	2	2672122	-	10	139200	102300	3800	4500	2,94	
	200	38	2,5	2,5	32222	NU222	1	229000	166000	3000	3600	4,993	
	240	50	3,0	3	2322	N322	4	391000	290000	2400	3000	12,2	
113	240	50	3,0	3	42322	NJ322	2	391000	290000	2400	3000	12,68	
	240	50	3,0	-	532322	-	4	464100	340780	2000	2300	11,3	
	210	52	5,0	-	292417	-	5	225300	273200	2170	2480	9,9	
	180	30	2,3	-	292919	-	5	183070	121830	2500	3000	2,531	
	140	16	1,1	-	1292822	-	5	45540	36050	2800	3600	0,428	
	160	26	2,3	-	292121	-	5	101000	72500	4000	4800	1,531	
	120	215	40	2,1	2,1	42224	NJ224	2	261100	322400	2400	2100	6,9
		160	30	1,1	1	272724	-	17	77200	62200	2500	2900	1,55
		135	22	1,3	1,1	1032924	-	1	80200	61200	2800	3600	1,46
		165	22/27	1,1	1	1272924	-	17	80200	61200	2800	3600	1,675
165		27/22	1,1	1,1	1672924	-	10	80200	61200	2800	3600	1,657	
180		28	2,0	1,1	32124	NU1024	1	134000	96500	3400	4000	2,55	
180		28	2,3	2,3	92124	NUP1024	3	134000	96500	3400	4000	2,69	
180		28	2,0	2,0	792124	-	15	134000	96500	3400	4000	2,47	
200		38	2,3	2,3	1032724	-	1	171600	140000	2600	3200	4,89	
200		48/38	2,0	2,0	1672724	-	10	171600	140000	2600	3200	5,74	
125	215	40	2,5	2,5	32224	NU224	1	260000	183000	2800	3400	6,43	
	215	58	3,0	3,0	2524	N2224	4	369000	280000	2600	3200	9,39	
	200	26	2,5	1	932125	-	1	174340	128200	2600	3200	3,332	
	130	172	27/22	1,1	1	672826	-	10	73910	56980	2600	3200	1,64
		180	24	1,5	1,1	1032926	-	1	97500	76500	2600	3200	2,06
		180	24	1,8	1,3	1002926	-	4	97500	76500	2600	3200	2,05
		200	33	2,0	1,1	32126	NU1026	1	165000	120000	3200	3800	3,95
		200	38/33	2,0	2,0	672126	-	10	165000	120000	3200	3800	4,34
		230	40	3,0	3,0	32226	NU226	1	259300	326200	1900	2200	7,63
	132,5	200	38	2,5	-	292222	-	5	229000	166000	3000	3600	4,022
135	180	28	2,3	-	292124	-	5	134000	96500	3400	4000	1,9	
140	190	24	1,8	1,3	1032928	-	1	85900	78400	2500	3200	2,08	
	190	37	1,8	1,3	3032928	-	1	176980	169370	2500	3200	2,92	
	210	33	2,0	1,1	32128	NU1028	1	172000	132000	3000	3600	3,75	
	300	62	4	4	32328	NU328	1	528000	374300	1600	1800	24,394	
145	180	18	1,3	1,3	122729	-	19	66500	57650	1000	1300	1,056	
	180	18	1,1	1	512729	-	19	67620	64180	1300	1600	0,982	
150	190	24	1,8	-	1292928	-	5	95030	76140	3000	3600	1,295	
	210	28	2,3	1,3	1032930	-	1	150660	122370	2400	3100	2,88	
	225	35	2,1	1,5	32130	NU1030	1	194000	155000	2600	3200	5,059	

Размеры/Dimensions					Обозначение/ Designation		Эскиз №/Drawing #	Грузоподъемность/ Load rating		Макс. Скорость/ Limiting Speed		Вес/ Weight
d	D	B	r min	r1 min				C	C _o	Пластичная смазка/ Grease	Жидкая смазка/ Oil	
мм/mm					Россия/ Russia	ИСО/ ISO		Н/Н		мин ⁻¹ /min ⁻¹		кг/kg
	225	35	2,5	1,8	42130	NJ1030	2	194000	155000	2600	3200	5,27
	210/248	28/37	2,0	-	832930	-	18	150660	122370	2400	3100	4,37
153	190	24	1,5	-	12922928	-	5	99600	153200	2040	2330	1,295
157	210	33	2,3	-	292128	-	5	172000	132000	3000	3600	2,65
158	195	20	1,8	-	292730	-	5	95030	76140	2600	3200	1,1
160	200	30/24	1,1	1,1	2672832	-	10	94180	84600	2600	3200	1,92
	220	28/38	2	1,1	1272932	-	17	150660	122370	2400	3000	4,22
	240	32	2,5	2,5	32832	-	1	214490	163680	2400	3000	5,375
	240	38	2,1	1,5	32132	NU1032	1	229000	173000	2400	3000	5,85
	240	48/38	2,5	1,8	672132	-	10	214490	163680	2400	3000	6,678
	290	48	3,0	3,0	32232	NU232	1	404900	531300	1500	1800	14,30
168,8	225	35	2,1	-	292130	-	5	193200	145700	1900	2200	3,44
169	250	42	4,0	-	292228	-	5	236200	342700	1670	1900	7,22
170	230	28	2,0	1,1	1002934	-	4	150300	124300	1800	2000	3,35
	215	27	2,1	-	2002834	-	4	74600	70800	3000	3500	2,56
	230	36/33	2	1,1	2672934	-	10	188500	163680	2000	2600	4,21
	235	28/65	2	-	272734	-	13	171350	140890	2000	2600	5,48
	260	28	1,8	1,8	7002134	-	4	192500	175000	2000	2600	5,96
	280	51	2,5	2,5	1032734	-	1	327000	441200	1500	1780	12,72
	310	52	3,7	3,7	32234	NU234	1	470000	628200	1500	1700	18
180	280	31	3,0	3,0	7032136	-	4	306400	494900	1740	1500	7,69
181	240	38	2,5	-	292132	-	5	229000	173000	2400	3000	4,738
181,5	215	22	1,3	-	1292834	-	5	95950	83560	3000	3500	1,57
190	260	33	2,3	1,3	1032938	-	1	183780	163680	2400	3000	6,038
	272	33	2,3	2,3	1032738	-	1	260800	377150	1500	1700	6,36
197	225	35	-	2,1	292130	-	5	189800	270200	1600	1900	3,438
200	310	51	2,1	2,1	32140	NU1040	1	380000	360000	1900	2400	15
	310	51	2,5	2,5	92140	NUP1040	3	380000	360000	1900	2400	15,8
	310	66/51	2,1	2,1	672140	-	10	380000	360000	1900	2400	16,01
205	285	30	2,5	2,5	512741	-	4	267800	445000	1400	1600	5,83
	280	32	2,1	2,1	112741	-	8	174400	250800	1400	1600	5,36
	280	32	2,5	2,5	1032941	NU1941	1	209700	340900	1400	1600	6,1
	280	46	2,1	-	292136	-	5	320480	246900	2000	2600	7,20
215	290	46	2,1	-	292138	-	5	337570	269340	1900	2400	7,600
220	280	24/62	-	-	272744	-	13	126480	121830	1400	1600	6,40
	340	56	3,0	3,1	32144	NU1044	1	492600	729800	1250	1400	18,9
230	330	36	-	-	2846	-	14	372750	312230	1400	1600	10,30
	330	36	-	-	92846	-	15	372750	312230	1400	1600	10,40
	330	36	2,5	1,1	692846	-	16	431190	381570	1400	1600	10,10
	330	36	-	-	802846	-	14	431190	381570	1400	1600	9,46
235	280	31	2	0,3	7892136	-	5	201800	194400	1400	1600	3,558
240	320	38	3,5	3,5	1032948M	-	1	262070	438970	1250	1430	8,37
255	345	35/38	4,0	3,5	1032751	-	1	385000	629200	1200	1300	9,92
260	320	38	2,5	2,5	1292948	-	5	277100	473600	1200	1400	6,11
280	380	46	2,1	2,1	1032956	-	1	411700	370300	1000	1200	16,9

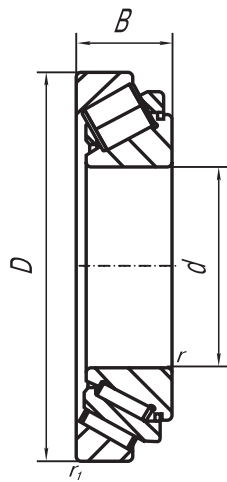

Эскиз 1
Drawing 1

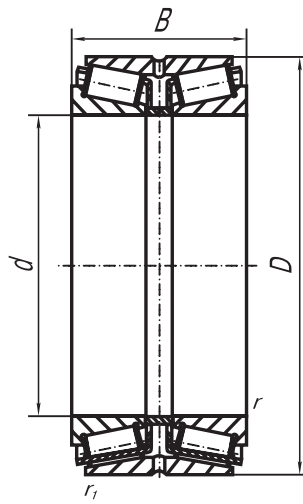

Эскиз 2
Drawing 2

Размеры/Dimensions					Обозначение/ Designation		Эскиз №/Drawing #	Грузоподъемность/ Load rating		Макс. Скорость/ Limiting Speed		Вес/ Weight
d	D	B	r min	r1 min				C	C _o	Пластичная смазка/ Grease	Жидкая смазка/ Oil	
мм/mm					Россия/ Russia	ИСО/ ISO		Н/Н		мин ⁻¹ /min ⁻¹		кг/kg
15	35	11	0,2	0,2	7202	30202	1	10900	10200	10000	12000	0,055
17	40	13,25	0,3	0,3	7203	30203	1	18600	17300	8700	10500	0,081
19,058	45,25	15,494	0,2	1,1	7804	11949/11910	1	43250	49100	7800	9300	0,129
20	47	15,25	0,3	0,3	7204	30204	1	26000	25100	7500	9000	0,127
25	52	16,25	0,3	0,3	7205	30205	1	32500	34100	6500	7800	0,156
26	57,15	17,452	0,5	1,3	7805	639154	1	39300	43100	6000	7200	0,226
30	62	21,25	0,3	0,3	7506	32206	1	44000	45700	5400	6500	0,29
35	72	24,25	0,5	0,5	7507	32207	1	63700	67200	4600	5600	0,449
40	68	19	0,3	0,3	2007108	32008	1	51100	67300	4600	5500	0,278
55	100	18	0,5	0,5	7211	30211	1	105370	127300	3220	3870	0,709
	100	26,75	0,5	0,5	7511	322100	1	106400	126800	3200	3900	0,852
80	140	35,25	0,7	0,7	7516	32216	1	171800	225600	2300	2700	2,21
105	180	49	0,7	0,7	7821	-	1	303800	434300	1700	2100	5,02
180	250	96,25	2,3	0,7	2097936	-	2	538000	1114600	1100	1400	13,2
190	260	45	0,7	0,7	2007938	32938	1	505700	818000	1100	1300	6,54
	290	64	0,9	0,9	2007138	32038	1	563400	954700	1000	1250	14,4
200	310	51	0,7	2,3	7740	-	1	446400	678600	980	1200	13,6
	250	24,5	0,7	0,7	7840	-	1	126000	228400	1100	1300	2,49

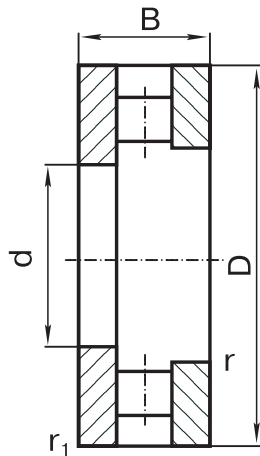

Эскиз 1
Drawing 1

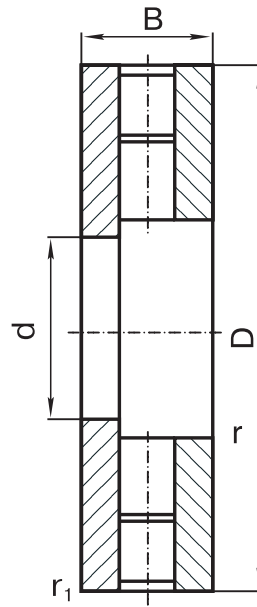

Эскиз 2
Drawing 2

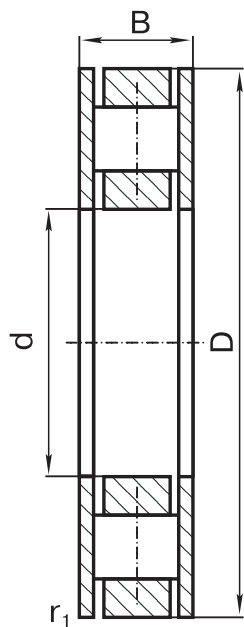

Эскиз 3
Drawing 3

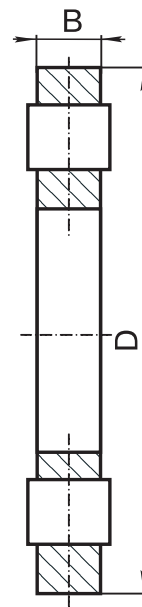

Эскиз 4
Drawing 4

Размеры/Dimensions							Обозначение/ Designation		Эскиз №/Drawing #	Грузоподъемность/ Load rating		Макс. Скорость/ Limiting Speed		Вес/ Weight
d	D	B	r min	r1 min	d1	D1				C	C _o	Пластичная смазка/ Grease	Жидкая смазка/ Oil	
мм/mm							Россия/ Russia	ИСО/ ISO		Н/Н		мин ⁻¹ /min ⁻¹		кг/kg
10	24	4		-	-	-	219700	-	4	6210	17200	20600	23500	0,009
	24	5,8		-	-	-	219800	-	4	5870	16000	20600	23500	0,014
12	26	5,7		-	-	-	219801	-	4	6700	19700	18400	21000	0,018
15/28	28/16	9	0,3	-	28	16	9102	81102	1	10400	24500	3200	4300	0,0299
17	30	5,7		-	-	-	219803	-	4	8180	27100	14900	17000	0,02
17/30	30/18	9	0,3	-	30	18	9103	81103	1	10800	27000	3200	4300	0,0321
20	35	4		-	-	-	219704	-	4	9000	32900	12700	14500	0,019
	35	5,8		-	-	-	219804	«LS2035+ АХК2035+ AS2035»	4	8580	30980	12700	14500	0,029
20/35	35/21	10	0,3	-	35	21	9104	81104	1	18480	37670	2800	3800	0,0474
25	42	6		-	-	-	219805	«LS2542+ АХК2542+ AS2542»	4	10500	42200	10400	11900	0,04
25/42	42/26	11	0,7	-	42	26	9105	81105	1	21140	44540	2200	3200	0,072
30	47	6		-	-	-	219806	-	4	11040	47870	9090	10390	0,046
30/47	47/32	11	0,7	-	47	32	9106	81106	1	22520	52020	2000	3000	0,0814
35	52	6,5		-	-	-	219807	«LS3552+ АХК3552+ AS3552»	4	12470	56320	8040	9200	0,057
35/68	68/37	20	1,0	-	68	37	9889307	89307	2	56020	88050	1500	2000	0,407
40	60	7,5		-	-	-	219808	-	4	19400	80300	7000	8000	0,085
40/78	78/42	22	1,0	-	78	42	9889308	89308	2	79020	126080	1500	2000	0,596
45	65	8		-	-	-	219809	«LS4565+ АХК4565+ AS4565»	4	20400	90300	6400	7300	0,1
	65	11	0,6	-	65	47	9709	-	1	25260	46620	1600	2000	0,123
50	70	8		-	-	-	219810	«LS5070+ АХК5070+ AS5070»	4	22000	100300	6100	7000	0,108
	95	27	1,1	-	95	52	9889310	89310	2	62030	90410	1200	1700	1,05
55	78	9		-	-	-	219811	-	4	29300	145200	5300	6000	0,157
	105	30	1,1	-	105	57	9889311	89311	2	126100	216130	950	1400	1,461
60	85	8,8		-	-	-	219812	«LS6085+ АХК6085+ AS6085»	4	29700	157900	4800	5500	0,178
	110	30	1,1	-	110	62	9889312	89312	2	73790	108670	950	1400	1,52
60,5	84,5	6,5		-	-	-	999912	-	3	47840	75000	950	1400	0,118
65	90	9,3		-	-	-	219813	«LS6590+ АХК6590+ AS6590»	4	32600	178400	4500	5200	0,202
	115	30	1,1	-	115	67	9889313	89313	2	85040	130670	950	1400	1,57
70	95	10,2		-	-	-	219814	-	4	37150	176000	4200	4850	0,238
	105	27	1,1	-	105	72	9214	81214	1	122930	324750	900	1300	0,921
	125	34	1,1	-	125	72	9889314	89314	2	124080	204050	920	1200	2,098
75	100	10,8		-	-	-	219815	-	4	43250	214400	4000	4500	0,265
	100	19	1,1	-	100	77	9115	81115	1	73750	246200	1100	1600	0,437
	110	27	1,1	-	110	77	9215	81215	1	120620	348400	850	1200	1,029
80	105	10,8		-	-	-	219816	-	4	42600	224600	3800	4300	0,28
	105	19	1,1	-	105	82	9116	81116	1	77780	278380	1000	1500	0,454
	115	28	1,1	-	115	82	9216	81216	1	133020	440560	850	1200	1,067
	170	64	2,1	-	170	80,2	9889416	89416	2	494050	781200	850	1200	7,43
85	110	19	1,1	-	110	87	9117	81117	1	77780	279640	1000	1500	0,481
	125	31	1,1	-	125	88	9217	81217	1	151040	462980	800	1100	1,45
	150	39	1,5	-	150	88	9889317	89317	2	262620	499130	800	1000	3,35
90	120	11,5		-	-	-	219818	-	4	54300	308000	3300	3800	0,411
	120	22	1,1	-	120	92	9118	81118	1	105970	367130	900	1300	0,762

Размеры/Dimensions							Обозначение/ Designation		Эскиз №/Drawing #	Грузоподъемность/ Load rating		Макс. Скорость/ Limiting Speed		Вес/ Weight
d	D	B	r min	r1 min	d1	D1				C	C _o	Пластичная смазка/ Grease	Жидкая смазка/ Oil	
мм/мм							Россия/ Russia	ИСО/ ISO		Н/Н		мин ⁻¹ /min ⁻¹		кг/кг
90	135	35	1,1	-	135	93	9218	81218	1	199930	296654	800	1000	1,95
100	135	12		-	-	-	219820	-	4	67400	443600	3000	3400	0,563
	120	14	0,7	-	119	101	1009920	-	1	54250	230630	850	1200	0,337
	135	25	1,1	-	135	102	9120	81120	1	140710	482560	850	1200	1,13
	170	42	1,5	-	170	103	9889320	89320	2	168100	280570	670	900	4,54
110	145	12		-	-	-	219822	«LS110145+ АХК110145+ AS110145»	4	71000	475200	2750	3100	0,611
	145	25	1,1	-	145	112	9122	81122	1	159490	574920	800	1100	1,22
	190	48	2,0	-	190	113	9889322	89322	2	247210	411550	630	850	6,4
120	155	12		-	-	-	219824	«LS120155+ АХК120155+ AS120155»	4	77900	538500	2500	2900	0,659
	155	25	1,1		155	122	9124	81124	1	153990	578860	800	1100	1,3
121	140,6	6					999723	-	3	59750	124310	600	800	0,158
125,2	149,7	6					899925	-	3	58410	129490	600	800	0,201
130	170	15		-	-	-	219826	«LS130170+ АХК130170+ AS130170»	4	101300	689000	2300	2700	1,03
	170	30	1,1				9126	81126	1	182090	694640	700	950	2,01
	190	45	1,5		187	133	9226	81226	1	324540	1062780	530	700	5,42
140	200	46	1,8		200	143	9228	81228	1	367600	1236370	530	700	4,75
145	180	26	4,7		178	146	9729	-	1	162168	728400	630	850	1,55
150	190	15,5		-	-	-	219830	-	4	111700	784080	2060	2350	1,21
	190	31	1,1		188	152	9130	81130	1	200580	841600	630	850	2,452
	250	60	2,1		245	154	9889330	89330	2	415650	758600	500	650	12,8
154	179,5	7,5	-				999931	-	3	92400	199580	480	630	0,259
160	200	7		-	-	-	219732	-	4	116700	831600	1940	2200	0,408
	200	15,5		-	-	-	219832	-	4	116700	831600	1900	2200	1,28
	200	31	1,1		200	162	9132	81132	1	205170	867330	630	850	2,5
	225	51	1,8		225	163	9232	81323	1	526490	1884300	450	600	6,4
185,5	209,5	7,5					999937	-	3	104240	251770	430	560	0,387
200	250	37	1,3		250	203	9140	81140	1	311030	1360130	530	700	4,64
215,5	239,5	7,5					999943	-	3	110210	295180	400	530	0,432
260	320	45	1,8		317	263	9152	81152	1	580862	3015190	400	530	8,54



КОЛЬЦА И ТЕЛА КАЧЕНИЯ

- Подшипниковые стали
ШХ15, ШХ15Ш, ШХ15СГ, ШХ15СГШ
- Нержавеющая сталь
95Х18Ш
- Теплостойкие стали
8Х4В9Ф2Ш, 8Х4В9Ф2ШД

RINGS AND ROLLING ELEMENTS

Bearing steels
52100 (ASTM A 295),
52100 (ASTM A 485)

Stainless steels
A 756 (ASTM A 756)

Hot-working steels
M 50

СЕПАРАТОРЫ

- Змейковые штампованные ленты
08КП, 08ПС, 10КП, 10ПС, 12Х18Н9,
12Х18Н9-Т, 08Х18Н10, 08Х18Н10Т,
Л63, Л68
- Массивные сепараторы
бронзы БрАЖМц 10-3-1,5, БрАЖН 10-4-4,
латуни ЛС59-1, ЛЦ40С,
алюминиевые сплавы Д1-Т, Д1-Т1, АК-4,
текстолит, фторопласт 4,
другие материалы

CAGES

Pressed metal ribbons
1010 (ASTAM A 29/A29M),
1015 (ASTAM A 29/A29M),
302 (AISI), 321 (AISI),
C 26800 (ASTM B 587)

Solid cages
C 6300 (ASTM B 171),
C 38000 (ASTM B 455),
AA 2017 (ANSI H35.2),
AA 2618 (ANSI H35.2),
other materials

1. ПОДШИПНИКИ ШАРИКОВЫЕ РАДИАЛЬНЫЕ ОДНОРЯДНЫЕ	1
2. ПОДШИПНИКИ ШАРИКОВЫЕ РАДИАЛЬНО-УПОРНЫЕ ОДНОРЯДНЫЕ	7
3. ПОДШИПНИКИ ШАРИКОВЫЕ РАДИАЛЬНО-УПОРНЫЕ ОДНОРЯДНЫЕ С 3-Х ТОЧЕЧНЫМ И 4-Х ТОЧЕЧНЫМ КОНТАКТОМ	11
4. ПОДШИПНИКИ ШАРИКОВЫЕ РАДИАЛЬНО-УПОРНЫЕ СДВОЕННЫЕ	14
5. ПОДШИПНИКИ РАДИАЛЬНО-УПОРНЫЕ ДВУХРЯДНЫЕ	17
6. ПОДШИПНИКИ РОЛИКОВЫЕ РАДИАЛЬНЫЕ С КОРОТКИМИ ЦИЛИНДРИЧЕСКИМИ РОЛИКАМИ	19
7. ПОДШИПНИКИ РОЛИКОВЫЕ КОНИЧЕСКИЕ	26
8. ПОДШИПНИКИ РОЛИКОВЫЕ УПОРНЫЕ	28
1. SINGLE-ROW RADIAL BALL BEARINGS	1
2. SINGLE-ROW ANGULAR-CONTACT BALL BEARINGS	7
3. SINGLE-ROW ANGULAR-CONTACT BALL BEARINGS WITH 3-POINT AND 4-POINT CONTACT	11
4. DUPLEX ANGULAR-CONTACT BALL BEARINGS	14
5. DOUBLE-ROW ANGULAR-CONTACT BALL BEARINGS	17
6. RADIAL ROLLER BEARINGS WITH SHORT CYLINDRICAL ROLLERS	19
7. TAPER ROLLER BEARINGS	26
8. THRUST ROLLER BEARINGS	28

ОАО «Завод Авиационных Подшипников», г.Самара (до 2002 г. назывался «Завод Специальных Подшипников») входит в состав Европейской подшипниковой Корпорации и является ключевым предприятием Дивизиона спецпродукции ЕПК.

Дивизион – крупнейшее и самое современное на данный момент на территории стран СНГ производство подшипников специального назначения, в том числе прецизионных. Ключевыми потребителями продукции Дивизиона спецпродукции являются авиационная и космическая промышленность, военно-промышленный комплекс, судостроение, атомная энергетика, высокоточное машиностроение, то есть те отрасли, где подшипник определяет работоспособность наиболее важных узлов изделия.

ОАО «ЗАП» производит более 5 тысяч наименований шариковых и роликовых подшипников из различных марок сталей диаметром от 10 мм до 600 мм и массой от 20 г до 60 кг. Подшипники могут быть изготовлены в высокоточном (2 – 4 классы), малошумном (Ш1-Ш8) исполнении, с использованием теплостойких сталей, нержавеющей сталей, стальных сплавов, бронзовых сплавов, алюминиевых сплавов, латуни, текстолита и других материалов. Мы также производим свободные детали.



Завод специализируется на производстве подшипников для двигателей самолетов и вертолетов, а также высокоточных подшипников для станкостроения. Наши подшипники применяются во всех советских и российских авиадвигателях. Продукция ОАО «ЗАП» также применяется в различных отраслях в широком спектре изделий военного и гражданского назначения: в ракетах, подводных лодках, кораблях, промышленных электродвигателях, танках, тракторах, автомобилях и т.д.

Open joint-stock company «Aviation Bearing Plant», (The former name «Special Bearings Plant») is located in Samara. Being a part of the European Bearing Corporation it is the key plant of its Special Bearings Division.

The EBC Special Bearings Division is the largest and currently the most up-to-date manufacturer of special bearings including high precision bearings in the CIS region. Among the key consumers of the Division produced bearings are such industries as aerospace, military, shipbuilding, nuclear power engineering, high-precision machine-building. These are the industries where the quality of bearings determines the operability of the most important assemblies of the product.

The plant currently produces more than 5000 types of various ball and roller bearings including double-row bearings, flange bearings and other modifications. Our products range from 10 mm to 600 mm in diameter and from 20 g to 60 kg in weight and are manufactured using special steels, hot-working steels, stainless steels, bronze alloys, aluminum alloys, brass and plastic. Bearings can be manufactured in high-precision version (ABEC-5, ABEC-7, ABEC-9), in low-noise version, with silver or black oxide plating, other special versions. We also produce separate parts: balls, rollers and needle rollers.



Aviation Bearing Plant specializes in producing bearings for aircraft and helicopter engines and high precision bearings for machine building. All Soviet- and Russian-made aero engines have our bearings installed. Our bearings are also utilized by many other industries in a wide range of military and civil products, being important parts of rockets, tanks, submarines, vessels, industrial electric motors, cars, tractors etc.



В составе ОАО «Завод авиационных подшипников» действует Специальное Конструкторское Бюро, к работе в котором привлечены ученые из Самарского Государственного Аэрокосмического Университета. Основные направления исследований включают: разработка конструкций специальных подшипников для авиадвигателей и малошумных подшипников для сверхвысоких скоростей вращения. Трансмиссионные подшипники нового поколения будут включать в себя гидродинамические демпрофилирующие устройства и уплотнения. Активно ведется подготовка к серийному производству подшипников сферической группы, а также гибридных подшипников с керамическими шариками.

Open joint-stock company «Aviation Bearing Plant» incorporates Special Construction Bureau with specialists from Samara State Aerospace University. Its main research fields include designing of special bearings for aircraft engines and low-noise bearings for ultrahigh rotation speed. Transmission bearings of the new generation will include hydrodynamic damping and sealing devices. Preproduction of spherical roller bearings with ceramic balls is going full speed ahead.

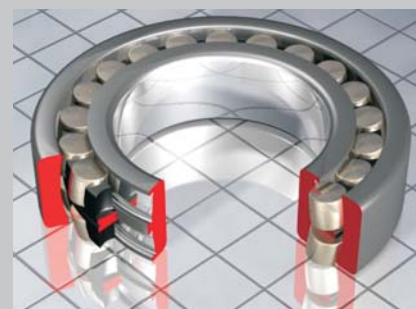

Новые разработки подшипников
New bearing desings

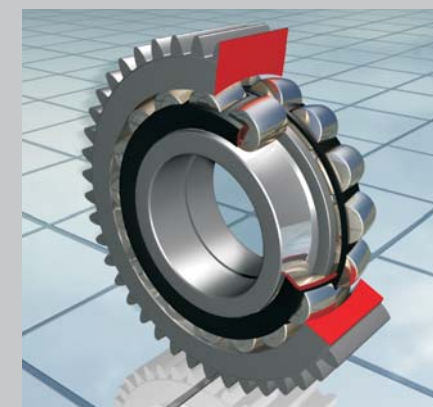
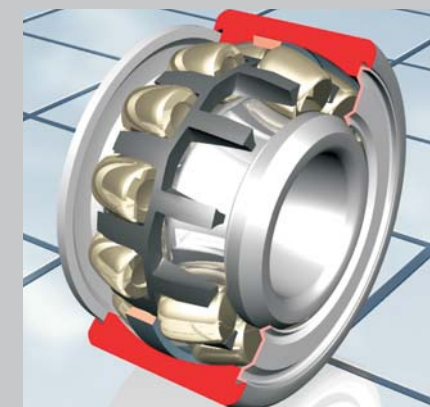

В 2004 г. ОАО «Завод Авиационных Подшипников» стало членом ассоциации «Союз Авиационного Двигателестроения» (АССАД), объединяющей более 100 компаний из 7 стран мира. Это способствовало укреплению двусторонних связей с ключевыми потребителями для оптимизации производственных программ и роста оперативности в решении технических вопросов.

В соответствии с решением Научно-технического совета АССАД, состоявшегося в феврале 2005 г. в г.Самаре, наш завод получил статус головного предприятия по поставкам подшипниковой продукции по спец.ТУ членам ассоциации.

In 2004 Open joint-stock company «Aviation Bearing Plant» was admitted to membership in the «Association of Aero Engines Manufacturers» (ASSAD) currently uniting more than 100 companies from 7 countries. This helped us to improve cooperation with the key customers to optimize our manufacturing programs and raise effectiveness of technical contacts. in accordance with the decision of ASSAD Scientific and Technical Council meeting held in February 2005 in Samara, Open joint-stock company «Aviation Bearing Plant» became the leading supplier of special bearings to the Association members.